



Citation for published version:

Hernando Gil, I, Shi, H, Li, F, Djokic, S & Lehtonen, M 2017, 'Evaluation of Fault Levels and Power Supply Network Impedances in 230/400V 50Hz Generic Distribution Systems', *IEEE Transactions on Power Delivery*, vol. 32, no. 2, pp. 768-777. <https://doi.org/10.1109/TPWRD.2016.2609643>

DOI:

[10.1109/TPWRD.2016.2609643](https://doi.org/10.1109/TPWRD.2016.2609643)

Publication date:

2017

Document Version

Peer reviewed version

[Link to publication](#)

© 2016 IEEE. Personal use of this material is permitted. Permission from IEEE must be obtained for all other users, including reprinting/ republishing this material for advertising or promotional purposes, creating new collective works for resale or redistribution to servers or lists, or reuse of any copyrighted components of this work in other works.

University of Bath

Alternative formats

If you require this document in an alternative format, please contact:
openaccess@bath.ac.uk

General rights

Copyright and moral rights for the publications made accessible in the public portal are retained by the authors and/or other copyright owners and it is a condition of accessing publications that users recognise and abide by the legal requirements associated with these rights.

Take down policy

If you believe that this document breaches copyright please contact us providing details, and we will remove access to the work immediately and investigate your claim.

Evaluation of Fault Levels and Power Supply Network Impedances in 230/400V 50Hz Generic Distribution Systems

Ignacio Hernando-Gil, *Member, IEEE*, Heng Shi, *Student Member, IEEE*, Furong Li, *Senior Member, IEEE*, Sasa Djokic, *Senior Member, IEEE*, and Matti Lehtonen, *Member, IEEE*

Abstract—In this paper, typical strengths, fault levels and source impedances are thoroughly analysed and calculated for the study of quality of supply in 230/400V 50Hz distribution systems. Considering all the disparity in distribution network design, this study is based on a comprehensive database containing typical arrangements and equipment in UK/European systems, as well as on fully documented generic network models supplying four residential load subsectors in the UK, i.e. from metropolitan to rural areas. Thus, this paper proposes an alternative method for determining reference values of network supply impedances and short-circuit fault levels at different points and locations of the medium-to-low voltage distribution system. The aim of this study is to provide a wider range of benchmark values than those stipulated in the IEC 60725 Standard, which only defines a single-reference threshold of public supply impedances for all types of distribution systems and residential customers. In order to assist network operators in the planning and design of their distribution systems, these values are further disaggregated and classified in this paper according to network/demand type.

Index Terms—Power demand, power distribution faults, power quality, power system planning, power system protection.

I. INTRODUCTION

Power distribution networks differ from each other in both characteristics and configurations, mainly depending on geographic location and type/density of served loads. This will determine important factors such as network strength, fault levels and source impedances, transformer ratings and feeder types/lengths, as well as the level of dedicated public/street lighting. Accordingly, a primary-to-secondary distribution system, consisting of both medium voltage (MV) and low voltage (LV) power supply networks, is designed based on power flows, voltage regulation, power losses and system fault levels [1], [2]. In this paper, the last factor, i.e. fault levels, has been used as the starting point for a proposed methodology to calculate reference values of public supply network

impedances at different points of the MV-to-LV distribution system. Typical strengths, fault levels and source impedances are thoroughly analysed and calculated for the quality of supply assessment in power distribution networks, supplying predominantly residential customers. For that purpose, the following four “generic residential load subsectors” have been used for the presented calculations, as defined in [3]: a) highly-urban (representing metropolitan areas and city centers), b) urban (city suburbs and bigger towns), c) suburban (towns), and d) rural (small villages).

In order to build typical distribution network models and to identify existing network arrangements and components in the UK, information on the power systems was obtained from different UK distribution network operators (DNOs) [4]-[10]. Moreover, existing and typical UK/European distribution system configurations were surveyed and identified (e.g. [11], [12]) to provide a realistic validation of the resulting network models and calculated values. Detailed information on all power distribution components was assembled as an all-inclusive database, where the required specifications, parameters, limits and settings were also collected from several manufacturers of power equipment, e.g. [13], [14].

The aim of this work is to provide a wider range of reference supply impedances and network fault levels than those provided in the technical report IEC/TR 60725:2012 [15], which proposes a different methodology for the calculation of public supply network impedances for use in power quality (PQ) analyses. The IEC report provides information and collected values of the supply system impedance from different countries, covering LV supply networks up to the point of common coupling (PCC) of several LV consumers. Therefore, it has been considered as the source of validation for the typical UK reference values calculated in this study. The information provided in the IEC report, which is considered not inclusive enough, will be further expanded and complemented, as the impact of MV systems upstream of the LV PCC is no longer neglected by the methodology presented in this paper. If, for example, the LV network is supplied from a MV circuit of considerable length, as in e.g. rural areas, the system design may allow for a voltage drop in the MV circuit, which the IEC report does not consider. Thus, the proposed methodology will provide reference impedance values considering the different network arrangements

I. Hernando-Gil, H. Shi and F. Li are with the Department of Electronic and Electrical Engineering, University of Bath, BA2 7AY, UK (e-mails: i.hernando.gil@bath.ac.uk, h.shi@bath.ac.uk, f.li@bath.ac.uk).

S. Djokic is with the Institute for Energy Systems, School of Engineering, University of Edinburgh, EH9 3DW, Scotland, UK (e-mail: sasa.djokic@ed.ac.uk).

M. Lehtonen is with the Department of Electrical Engineering, School of Electrical Engineering, Aalto University, Aalto FI-00076, Finland (e-mail: matti.lehtonen@aalto.fi).

typically used at the four “generic residential load subsectors”. These will help to evaluate the most appropriate system capacity for the interconnection of distributed resources to the network, likely to increase PQ related disturbances.

In addition, the paper aims to investigate whether the disaggregated values of both fault levels and source impedances can be calculated, or at least assessed by the network modelling approach, as opposed to the measurement based approach in [15], which would not always be viable. The objective is to provide an alternative general technique which might complement future revisions of the IEC/TR 60725, especially the impedance measurement and survey approach. Accordingly, the spectrum of reference impedances calculated in this paper might be of direct use in other measurement-based standards, e.g. IEC 61000-3 – Parts 3-3 [16], 3-11 [17] and 3-12 [18], in which these reference values are incorporated for the testing of electrical equipment against disturbance emission limits.

II. RESIDENTIAL LOAD SUB-SECTORS

Although the purpose of every residential dwelling and its individual loads is generally similar, it is possible to divide the residential load sector into four subsectors, based on the location, size and type of dwelling, as studied e.g. in [19]. The level of street/outdoor lighting will also be influenced by the location, while differences will also exist in terms of the size of distributed generation (DG) that is likely to be located in close proximity to the residential areas. Therefore, based on these general characteristics and parameters, the residential load sector can be divided into the four following subsectors: highly-urban, urban, suburban and rural [3], [20].

A. Highly-Urban (HU) Residential Load Subsector

This subsector is represented by flat-type dwellings, usually found in large cities, in multi-storey and high-rise buildings and it is characterised by highly concentrated power demands. Three-phase motors may be used for elevators, pumps and central air-conditioning systems, which are usually not present or low in other residential subsectors. The number of rooms per dwelling is expected to be lower than in other subsectors, with additional interior lighting load for illumination of communal areas. The public/street lighting is also greater than in other subsectors, due to the presence of parking spaces and higher required lighting levels in metropolitan areas.

B. Urban (U) Residential Load Subsector

This subsector consists of house-type dwellings, ranging from one to few-storey buildings, located in city urban areas and it is characterised by medium to high concentration of power. As the average number of residents and rooms per household is greater than in the HU subsector, higher power demands per household may occur. The public/street lighting is slightly reduced in comparison with the HU subsector.

C. Sub-Urban (SU) Residential Load Subsector

This subsector is similar to the urban subsector, representing individual house dwellings located in city suburban areas and

towns in close proximity to big cities. The load mix is similar to the urban subsector but the contribution from public/street lighting is likely to be further reduced. It is also characterised by medium power density.

D. Rural (Ru) Residential Load Subsector

House-type dwellings in this subsector are one to few-storey buildings, located in more remote areas. Power density is low and some (smaller) three-phase motors may be used for agricultural works. Another notable difference is that no public/street lighting is present. Furthermore, the connection of larger DG is possible in this subsector.

III. LV SUPPLY: TYPICAL RESIDENTIAL PREMISES

Because there is a large variety of statutory supply voltages, permitted variations and specifications used by supply authorities for power system plant and equipment, a specific analysis with particular service capacities was considered essential. Three-phase (3-ph), four-wire, distribution systems are used worldwide to supply LV consumers, with nominal voltages in the region of 230/400 V (e.g. Fig. 1 and Fig. 2¹).

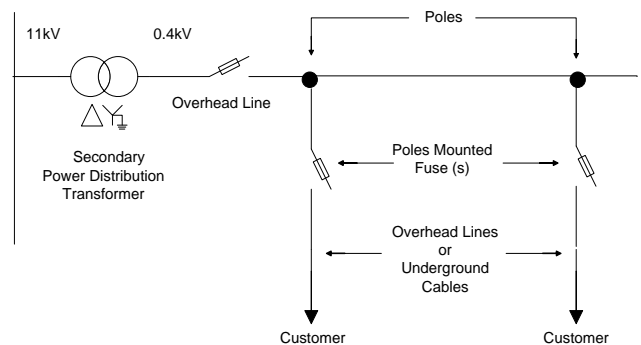

Fig. 1. Typical arrangement for overhead LV distribution systems [21].

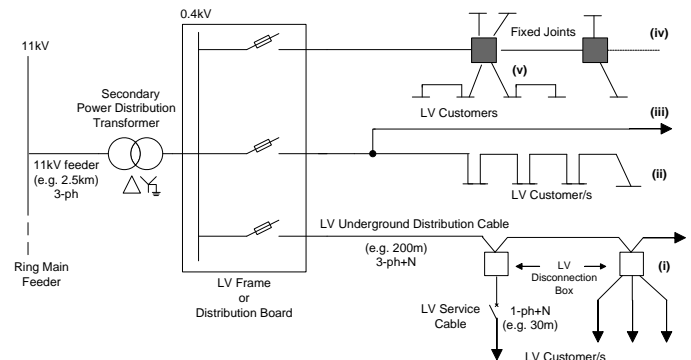

Fig. 2. Typical arrangement for underground LV distribution systems [21].

¹ Fig. 2 presents different LV service cable layouts: (i) One cable supplies a number of disconnection boxes with fuses, similar to the overhead line (OHL) layout, so several customers can be supplied from one box; (ii) Cheaper arrangement owing to the linking connections between customers, but do not permit such individual good protection facilities as the LV disconnection boxes; (iii) Arrangement for individual large or remote customers, i.e. “dedicated supply”; (iv) Situation with fixed underground joints, which are much cheaper than cable disconnection boxes or cabinets although the selective protection facility is not possible; (v) Arrangement proved to be cost effective where each customer in a terraced house has his/her own service and this simple arrangement meets the local safety regulations.

However, there are considerable variations in the way in which the supplies to individual consumers are connected to 3-ph systems. In the UK, it is unusual to take more than one phase into a residential consumer's premises; consequently, both large loads less than 15 kVA (i.e. $\leq 75A$ per phase) and lighting circuits are supplied single-phase (1-ph), i.e. between line and neutral at 230 V. Thus, the typical/generic network arrangements considered for overhead and underground LV power distribution are illustrated in Fig. 1 and Fig. 2.

A. Generic MV/LV Distribution Network Models

After identifying the general demand characteristics for the different residential load subsectors, the next step is to use typical/generic network models capable of representing the actual distribution systems supplying their secondary substations in each case. In terms of network planning, the primary distribution system (11 kV or 6.6 kV in the UK) is typically a complex interconnected ring network containing many substations (indoor, outdoor or pole mounted), while the secondary distribution system (0.4 kV) is generally a radial network because of cost [2]. As previously discussed, each of them differs in arrangement and conditions depending on location. In cities, load density is high as compared to rural areas and therefore line lengths are shorter (typically less than 10km [21]), so underground cables are typically used to improve reliability of supply and for aesthetics. On the other hand, in rural areas the primary distribution is by means of OHLs and the substations are generally of the outdoor type, either pole mounted or switchgear type [21], [22].

TABLE I
TYPICAL LV LINE CROSS-SECTIONS FOR RESIDENTIAL LOAD SUBSECTORS

Highly-Urban / Urban Underground Network	
Interconnector	Cross-Sections (mm^2)
Main trunk feeder	4 x 300(Al); 4 x 185(Al); 4 x 120(Al)
Lateral spurs	4 x 185(Al); 4 x 120(Al); 4 x 95(Al)
Service connection	4 x 120(Al); 4 x 95(Al); 4 x 70(Al); 4 x 35(Al); 2 x 35(Cu)
Sub-Urban / Rural Aerial Network	
Interconnector	Cross-Sections (mm^2)
Main trunk feeder	4 x 120(Al); 4 x 95(Al); 4 x 70(Al)
Lateral spurs	4 x 95(Al); 4 x 70(Al); 4 x 50(Al)
Service connection	4 x 70(Al); 4 x 50(Al); 4 x 35(Al); 2 x 35(Cu); 2 x 25(Cu)

Therefore, considering all the disparity in distribution network design, the study presented in this paper is based on the fully documented generic models previously calculated and presented in [3] and [23]. Based on the database previously described, for each of the four residential load subsectors, as well as for each voltage level commonly used for electricity distribution (LV and MV), detailed and updated specifications for all power components and relevant system loading conditions are considered. For example, Table I provides line cross-sections typically used in the UK [21]-[24] for different LV distribution main feeders and spurs, as well as for each residential load subsector defined. As specified in Table I, LV

underground lines are mainly encountered in highly-urban and urban areas, while in suburban and rural areas, OHLs are more commonly used. These were traditionally constructed by aluminium (Al) or copper (Cu) bare conductors [24], however ease of installation and environmental issues have led to the extensive use of bundled insulated overhead conductors over the last decades.

Another important component of LV distribution networks is the secondary MV/LV substation, which typically comprises a single transformer with a rating of a few hundred kVA up to 1 MVA [25]. Considering practical procedures from DNOs for network planning and arrangement in existing UK/European LV distribution networks [26], [27], Table II shows the maximum distribution radius an 11/0.4 kV transformer is typically designed to supply depending on demand type/subsector. This is based on maximum line lengths for the allowed voltage drop limit, which in the UK LV networks must remain above 0.94 p.u. [28]. For each load subsector (HU, U, SU and Ru), the most typical/used secondary transformer is selected to model the generic distribution networks proposed for analysis in this paper.

TABLE II
MAXIMUM DISTRIBUTION RADIUS OF SECONDARY TRANSFORMERS

Load Subsector	Max. Length (m)
Highly-Urban	110
Urban	200
Suburban	300
Rural	800

IV. FAULT LEVEL AND SOURCE IMPEDANCE CALCULATION

The system impedance associated with the supply to the premises of a typical residential consumer is mainly determined by the strength of the supplying network (i.e. system configuration and components). These are designed based on the average value of maximum power demand of all the consumers connected to a typical network, and the steady state voltage drop at maximum load used to design the system [15]. Usually, as power demand increases, so does the strength of the supplying network. Thus, fault levels are used in this paper as the starting point for the proposed methodology to calculate benchmark values of public supply network impedances at different points of the MV/LV distribution system.

This has been done by extracting information from UK DNOs about system fault levels (and associated X/R ratios) at the secondary busbar of 33/11 kV primary substations, and from this value, by calculating the upstream 3-ph system impedance (Z_{SYS}) at that point of the distribution network. Then, by using the MV and LV power component database created, the different impedances of all system components encountered along the route (transformers, MV/LV feeders, etc.) down to the end-user premises (LV supply) have been added up in order to calculate realistic values of public supply network impedances. These range of complex values will be

directly compared against the single-reference value provided in the technical report IEC/TR 60725:2012 [15] for UK residential consumers, for 1-ph connections at 50 Hz.

As primary and secondary distribution configurations vary depending on location and load to supply, in order to decide which components to consider (transformer rating, feeder type/length, etc.), the four subsectors defined in Section II were used for these calculations. Accordingly, four specific UK locations were selected: Birmingham city centre (highly-urban), Aberdeen (urban), Oban (suburban) and Glencoe (rural). Obviously, each location presents different network configuration and characteristics (i.e. underground cable or OHL system), and may not be representative of other similar areas. As one of the key aspects affecting the design of circuit lengths in LV networks is the allowed voltage drop, this study concentrates on the maximum line lengths, i.e. on the “worst served customers”. Thus, the results obtained should be considered as an indicator for the direct comparison of system complex impedances and fault levels at different UK locations, as well as for the study of the less favourable case, in comparison with the values presented in Table 1 of [15].

A. UK Case Study: Urban Load Subsector

In order to illustrate the methodology undertaken for the four residential subsectors, the analysis presented in this section focuses on the urban subsector, where several meshed underground distribution networks operated by a UK DNO [5] were selected at different metropolitan areas of Scotland. More particularly, the existing urban network arrangements in three Scottish cities were considered for comparison: Aberdeen, Dundee and Inverness. As shown in Table III, when comparing the 3-ph system complex impedances at different 11 kV busbars of these networks (with 100 MVA base), it was important to note the similarity in terms of X/R ratios, fault levels and supply impedances.

TABLE III
COMPARISON OF 11 kV SYSTEM IMPEDANCES AT DIFFERENT URBAN LOCATIONS IN THE UK

Urban UK Location	11kV 3-ph System Impedance (Z_{SYS})	X/R Ratio
Aberdeen (QUEENS1A)	0.0569 + j0.6822 p.u.	12
Dundee (LOCHEE)	0.0414 + j0.6636 p.u.	16
Inverness (RAIGMO1A)	0.0638 + j0.6889 p.u.	10.8

As the 11 kV busbar in Aberdeen presents values around the average X/R ratios in urban areas, it is selected as the case study for the urban subsector in this paper. In particular, as shown in Fig. 3, the 11 kV busbar ‘QUEENS1A’ at the primary substation ‘Queens Lane North’, from the Woodhill 33 kV bulk supply point (BSP), was selected. At that network location, apart from the supply impedance Z_{SYS} presented in Table III, a fault level of 141 MVA was derived from the DNO’s system characteristics provided in Table IV.

TABLE IV
SYSTEM’S FAULT CHARACTERISTICS AT ‘QUEENS1A’ 11 kV BUSBAR [5]

Short-Circuit Currents		Circuit Breaker Ratings	
3-ph peak make	3-ph rms break	3-ph make	3-ph break
22 kA	7.4 kA	46.9 kA	18.4 kA

Therefore, the fault level, or ‘short-circuit apparent power’ (S_{SC}) is calculated by applying:

$$S_{SC} = \sqrt{3} \cdot U \cdot I_{3ph-rms-break} = \frac{U^2}{|Z_{SYS}|} = 141 \text{ MVA} \quad (1)$$

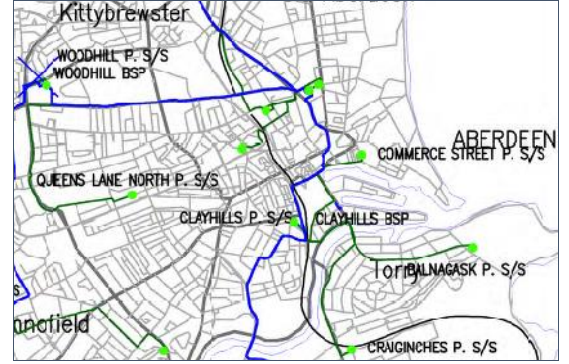

a) network map of Aberdeen (Scotland, UK)

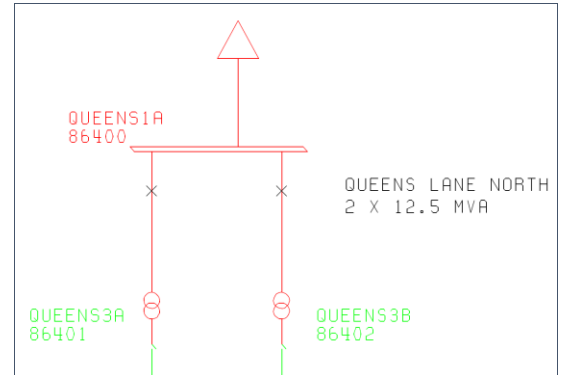

b) selected 11kV busbar of Woodhill 33kV system

Fig. 3. Existing urban network arrangement considered for system fault level analysis [5].

In (1), U is the system’s line voltage at ‘QUEENS1A’ busbar (i.e. 11 kV), $I_{3ph-rms-break}$ is the expected rms short-circuit current (i.e. 7.4 kA) as a result of the system’s fault level at that point, and Z_{SYS} is the 3-ph supply system impedance considered from Aberdeen, in ohms (i.e. $0.0712 + j0.8551 \Omega$), with an X/R ratio = 12.

Once the system fault level and supply impedance are known at the urban point of study, the different power components encountered along the route down to the LV customers’ supply (i.e. PCC) must be included in the analysis. For this purpose, the typical configurations and characteristics of MV/LV transformers and distribution lines previously described for the four different subsectors were used.

According to the network parameters and arrangements discussed in Section III and provided in [3], for the urban subsector, the underground circuit path leading to the end-user premises is therefore composed of the power components selected from Table V and Table VI.

TABLE V
TYPICAL PARAMETERS OF 11/0.4 kV DISTRIBUTION TRANSFORMERS

Load Subsector	Type	Rating (kVA)	Vector Group	Tapping Range	Basic Impulse Level (kV)	Load Losses at 75°C (W)	No-Load Losses (W)	Z (%)	Model Parameters (Z on secondary side)	
									R_{LV}	X_{LV}
(p.u. on 100MVA base)										
Highly Urban	Pre-fabricated	1000	Dyn11	$\pm 5\%$ in 2.5% taps	75	11000	1350	4.75	1.1	4.62
Urban	Ground/Pad Mounted	500				5100	680		2.04	9.28
Suburban	200	2900				540	7.5		22.5	
Rural	Pole Mounted	50				1100	190		4.5	43.72

TABLE VI
11/0.4 kV FEEDER CIRCUITS CONNECTING END-USER PREMISES IN THE FOUR GENERIC RESIDENTIAL SUBSECTORS

Voltage (kV)	Length (m)	Line Type (Configuration)	Cross Sectional Area (CSA) (mm ²)	Positive Sequence Z_{ph}/km	Max. Current (Amps)	
				$(R_{ph} + jX_{ph}) / km$ (p.u. on 100MVA)		
HIGHLY-URBAN						
11 kV	1500	Underground Feeder Cable (3-core PICAS cable - screened, stranded Al)	300	0.099	0.063	525
0.4 kV	110	Mains Distribution Cable (EPR or XLPE 0.6/1 kV 4x(CSA) Al/Cu (earth) CNE)	300	63.63	47.06	465
0.4 kV	40	Service Connection Cable (PVC or XLPE 0.6/1 kV 1x(CSA) Al/Cu (neutral/earth) CNE)	35	491.61	42.66	120
URBAN						
11 kV	2500	Underground Feeder Cable (3-core XLPE stranded/solid Al with 95 or 70 mm ² Cu wire screen)	185	0.123	0.066	415
0.4 kV	200	Mains Distribution Cable (EPR or XLPE 0.6/1 kV 4x(CSA) Al/Cu (earth) CNE)	185	89.84	43.68	355
0.4 kV	30	Service Connection Cable (PVC or XLPE 0.6/1 kV 1x(CSA) Al/Cu (neutral/earth) CNE)	35	491.61	42.66	120
SUBURBAN						
11 kV	5000	Overhead Feeder (AAAC [75°C] 100 mm ² Oak AL4)	100	0.147	0.262	395
0.4 kV	300	Aerial Bundled Conductor (ABC) XLPE 4x(CSA) Al	95	171.12	53.47	228
0.4 kV	20	Service Connection Cable (PVC or XLPE 0.6/1 kV 1x(CSA) Al/Cu (neutral/earth) CNE)	25	688.04	24.83	100
RURAL						
11 kV	5000	Overhead Feeder (AAAC [75°C] 100 mm ² Oak AL4)	100	0.147	0.262	395
11 kV	3000	Overhead Feeder (ACSR 54/9 mm ² 11kV)	50	0.216	0.207	290
0.4 kV	800	Aerial Bundled Conductor (ABC) XLPE 4x(CSA) Al	50	342.78	53.47	168
0.4 kV	15	Overhead Service Connection (0.6/1 kV ABC (XLPE) 2x(CSA) Al (neutral/earth) CNE)	35	491.41	23.67	120

In terms of distribution and cable lengths of the supplying circuit path, the less favourable case has been considered by taking the maximum length values provided in the network models [3] and Table II. For example, the generic 11 kV feeder, supplying a high-to-medium load density in urban areas, is well represented by a line length of less than a few kilometers (as compared to rural arrangements), i.e. between 2.5 and 3 km (Fig. 4).

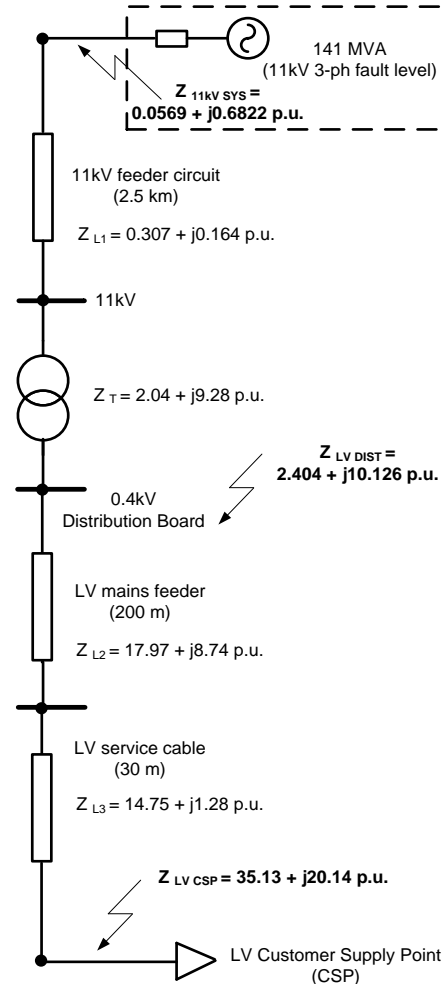

Fig. 4. Network model for determining MV/LV system fault levels and supply impedances in urban areas.

On the LV supply side, as shown in Table II, the maximum distribution radius of the generic 500 kVA transformer in an urban area is approximately 200 m (i.e. length considered for the LV mains distribution cable in the connecting circuit of Fig. 4), thus the analysis is based on those residential consumers located farthest from the MV infeeding substation and trunk feeder, i.e. worst served customers/scenario. Regarding the 1-ph service cable connecting the customers' PCC at LV level, 30 metres is the generic length considered in this study for service supply in an urban residential network. Fig. 4 shows the single-line network model considered for the calculation of different fault levels and supply impedances in a typical/generic UK urban area. All system parameters are provided in per unit, on 100 MVA base, so as to facilitate the

TABLE VII
COMPARISON OF MAX/MIN SYSTEM FAULT LEVELS AND SUPPLY IMPEDANCES PER RESIDENTIAL LOAD SUBSECTOR

Type of Network	(A) MV (11kV Supply)						(B) LV Distribution Board (0.4kV Supply)						(C) 0.4kV Customer Supply Point (CSP)					
	Fault Level (3-ph)		System Impedance (3-ph)				Fault Level (3-ph)		System Impedance (3-ph)				Fault Level		LV Public Supply Network Impedance			
	High	Low	R (min)	X (min)	R (max)	X (max)	High	Low	R (min)	X (min)	R (max)	X (max)	High	Low	R (min)	X (min)	R (max)	X (max)
	(MVA)		(p.u. on 100 MVA)				(MVA)		(p.u. on 100 MVA)				(MVA)		(p.u. on 100 MVA)			
Highly-Urban	209	167	0.029	0.476	0.177	0.571	19.15	18.71	1.13	5.09	1.27	5.19	4.58	3.29	20.75	6.80	27.93	12.07
Urban	141	109	0.057	0.682	0.363	0.846	9.82	9.61	2.10	9.96	2.40	10.13	4.93	2.47	16.84	11.24	35.13	20.14
Suburban	112	43	0.169	0.865	0.901	2.174	4.07	3.84	7.67	23.36	8.40	24.67	3.09	1.18	21.43	24.21	73.50	41.53
Rural	28	17	0.638	3.478	2.019	5.408	1.08	1.05	44.36	82.08	45.74	83.99	1.02	0.28	51.73	82.72	327.31	127.31

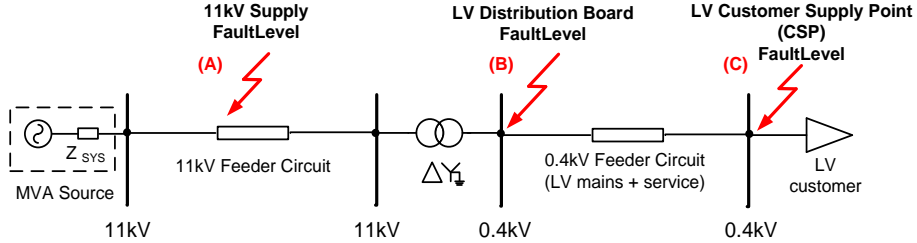

Fig. 5. Single-line circuit diagram for calculation of fault levels at different points of MV/LV networks.

aggregation of all impedance values down to the LV customer supply point (CSP). For example, in the generic urban network of study, the resulting system impedance value associated with the LV CSP in Fig. 4 is $Z_{LV_CSP} = 35.13 + j20.14$ p.u. Therefore, this complex value (Z_{LV_CSP}) for power supply in urban areas is directly comparable with the reference values provided by the technical report IEC/TR 60725:2012 [15] for UK residential consumers.

V. REFERENCE VALUES OF MV/LV FAULT LEVELS AND PUBLIC SUPPLY NETWORK IMPEDANCES

For each load subsector, as primary and secondary distribution configurations vary depending on location and demand supplied (e.g. underground or overhead arrangement), the first step was to calculate the aggregate system impedance associated with the power supply at different levels of the MV/LV distribution network. These are fault levels and supply impedances calculated at 11 kV level, i.e. at the secondary busbar of the infeeding 33/11 kV substation, and 0.4 kV level, i.e. at the LV distribution board and CSP. Thus, the resulting Z_{LV_CSP} represents the overall LV supply network impedance, and the aggregate demand is equal to the sum of all residential customers connected at the point of common coupling. The network aggregation methodology is based on work described in [29] and [30], where a technique for reducing a radial distribution network into one single line equivalent impedance was developed for fast computation of power system analyses. Also, a comparative assessment of existing research in the topic area, i.e. modelling of equivalent Thevenin's impedance [31]-[33], was carried out to provide similar background to the work presented in this paper. The established technique can be summarised in two steps:

1. Calculate the equivalent system impedance at every supply point (i.e. location) of the circuit path. This is the summation of all impedances down to each network location, including multiple power components such as series/parallel feeders, transformers, etc. This is expressed by (2).

2. Determine the overall LV supply network impedance by summing all equivalent system impedances calculated in Step 1. This step is described by (3).

$$Z_{location}(i) = \sum_{n=1}^N Z_{component}(n) \quad (2)$$

$$Z_{LV_CSP} = R_{LV_CSP} + jX_{LV_CSP} = \sum_{i=1}^I Z_{location}(i) \quad (3)$$

In (2) and (3), $Z_{component}(n)$ is the impedance value offered by each network component n at location i in the system (i.e. in this case at 11 kV level, and 0.4 kV level at the LV distribution board and CSP), $Z_{location}$ is the sum of all component impedances at location i , N is the total number of network components (i.e. feeders, transformers, etc.), I is the number of network locations, and Z_{LV_CSP} , R_{LV_CSP} and X_{LV_CSP} are the resulting system impedance, resistance and reactance values at the customer LV supply point. Accordingly, Table VII provides the reference values of the system impedance ($Z_{location}$) and fault levels calculated at different points of the UK-generic MV/LV distribution system, as outlined in Fig. 5, for each residential load subsector. Since distribution networks present a wide range of fault levels and system impedances, the values calculated in Table VII cover both lower and higher end of the spectrum expected at each network level. These enable to approximate the percentage of customer sites that would be above/below their proposed reference levels, e.g.

98% or 90% [15], as well as to assess how source impedances vary along the generic MV and LV supplying feeders.

A. Network Generalisation Approach

Based on the results in Table VII, it is possible to estimate the reduction in fault levels (and thus increase of $Z_{location}$) due to the length of supplying circuits in generic distribution networks, both at MV and LV, as well as for different load subsectors. Although feeder lengths have a considerable impact on the variance of high/low fault levels at points (A) and (C) in Table VII (Fig. 5), this difference is not so significant at point (B), mostly due to the big influence of the transformer impedance at that particular system level.

In order to measure the impact of each network component on fault levels and source impedances, a generalisation approach is carried out by applying sensitivity analysis [34] to all input parameters previously considered. The generalised concept could be directly extrapolated to any type of network worldwide, so as to meet all possible system configurations. Thus, the sensitivity of fault levels with respect to the variant feeder lengths can be quantified by a gradient as in (4):

$$\nabla_X f(z) = \frac{\partial f(z)}{\partial x_1} e_1 + \dots + \frac{\partial f(z)}{\partial x_n} e_n \quad (4)$$

Where, $f(z)$ refers to the fault level function based on feeder impedances z , $X=(x_1, x_2, \dots, x_n)$ is the set of all variant feeder lengths, and the orthogonal unit vector e_i represents the unit directions of feeder length x_i . By applying the chain rule, the formulation in (4) can then be converted to the format in (5) for the purpose of easy calculation [35]:

$$\nabla_X f(z) = \frac{\partial f(z)}{\partial z} \cdot \frac{\partial z}{\partial x_1} e_1 + \dots + \frac{\partial f(z)}{\partial z} \cdot \frac{\partial z}{\partial x_n} e_n \quad (5)$$

The resulting fault level gradients at three different points of the generic supplying network, i.e. points (A), (B) and (C), are presented in Table VIII in the form of max/min values, with respect to two variant feeder lengths: MV circuit and LV mains. The rate of change can be measured in either MVA/km or kVA/m. As previously anticipated, fault level at LV points is not particularly sensitive to the MV feeder length variance, mostly due to the relevant impact of transformer impedance.

TABLE VIII

MAX/MIN FAULT LEVEL GRADIENTS IN GENERIC NETWORKS ACCORDING TO MV/LV CIRCUIT LENGTHS

$ \nabla_X f $ (MVA/km)		(A) MV Supply		(B) LV Supply		(C) LV CSP	
		max	min	max	min	max	min
MV Feeder Circuit	HU	30.32	25.13	3.04E-01	2.97E-01	2.37E-02	1.25E-02
	U	16.32	12.94	8.67E-02	8.55E-02	3.39E-02	8.53E-03
	SU	36.27	5.44	4.87E-02	4.35E-02	2.85E-02	3.61E-03
	Ru	2.14	0.86	3.40E-03	3.23E-03	3.11E-03	2.02E-04
LV Mains Feeder	HU					15.64	8.34
	U					23.90	6.11
	SU					14.81	2.49
	Ru					2.38	0.28

The two more sensitive scenarios to be considered in generic distribution networks, i.e. at MV supply (point A) and LV CSP (point C), are further represented in Fig. 6 for the four load subsectors. This bi-dimensional analysis perfectly describes how different network structures might impact the sensitivity of wider network fault levels/source impedances.

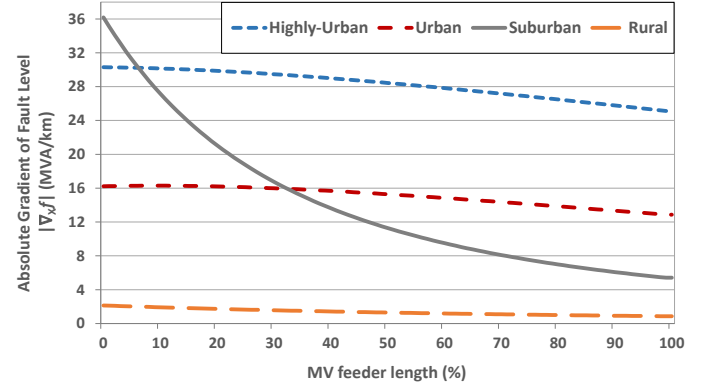

a) Impact of MV feeder length on fault levels at MV supply: network point (A)

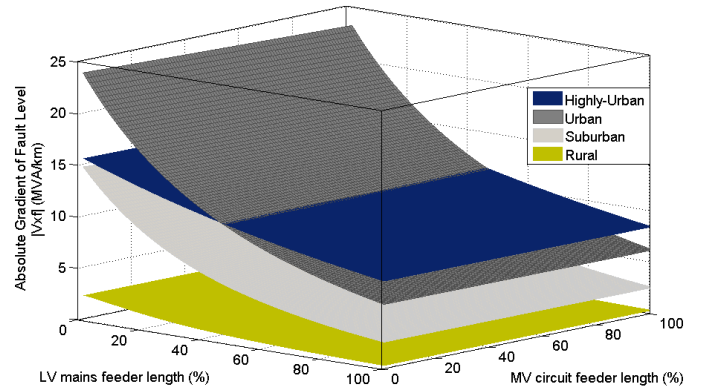

b) Fault level gradients at LV CSP: network point (C), in relation to two variant feeder lengths (LV mains and MV circuit)

Fig. 6. Gradient of fault level variations according to circuit length in four generic distribution networks (HU, U, SU and Ru).

B. UK-Generic Distribution System Fault Levels

For each network type in Table VII, and for each voltage level of the supplying distribution circuit (i.e. 11 kV or 0.4 kV), once the aggregate value of $Z_{location}$ is known at a location i in the system (Fig. 5), the corresponding fault level value at that particular supply point i is derived according to (1). However, only at 11 kV level (i.e. at the secondary busbar of the infeeding 33/11 kV substation) it is possible to extract the DNO's information on the typical 3-ph rms short-circuit currents ($I_{3ph-rms-break}$) at the four network locations selected in the UK: Birmingham city centre (highly-urban), Aberdeen (urban), Oban (suburban) and Glencoe (rural).

The characteristics of the equivalent circuit impedance or fault current at a particular bus of a distribution system might not always be available from DNO's actual data. Consequently, the fault MVA level is firstly calculated in this paper as an alternative representation of the capacity strengths at the various buses in the four generic distribution systems, regardless their voltage levels (Table VII). These fault MVA values can be used by DNOs for the planning and expansion of

power distribution systems at different network locations, i.e. from highly-urban to rural areas. Fig. 7 provides a comprehensive comparison of MV and LV short-circuit levels to be potentially experienced at different points/locations of the British power distribution system. Accordingly, the results provide a conservative estimation of the different strengths offered by each network type, location, and level to an occasional fault in the system. Highest values of 209 MVA are obtained for strong, meshed highly-urban networks at 11 kV level, as compared to the lowest values of 0.28 MVA resulting in radial, OHL rural systems at the 0.4 kV CSP.

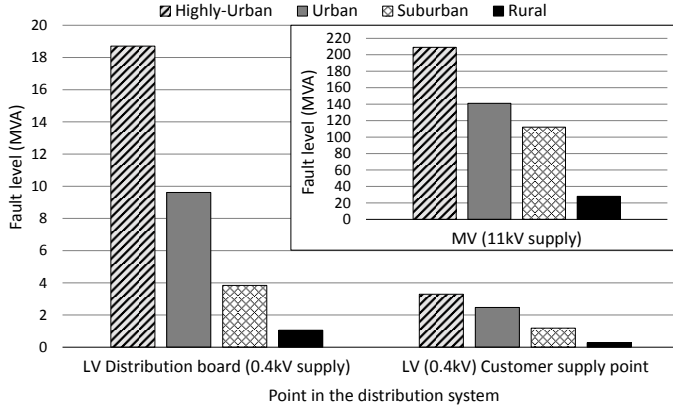

Fig. 7. Comparison of MV (11kV) and LV (0.4kV) system fault levels at different points/locations of the power distribution network.

When connecting a facility to a system, DNOs typically consider minimum fault MVA data as an essential parameter for checking quality of supply and PQ compliance, such as voltage issues, flicker, etc. [36], [37]. This approach can be used to estimate the limits at lower system levels with regard to their hosting capacity for distributed resources. DG set new demands to both protection and voltage control, whereas new disturbance emitting loads (e.g. electric vehicles) together with inverter-interfaced generation units (e.g. photovoltaic systems), are likely to increase PQ related issues in the grid. On the other hand, maximum fault MVA data is an important factor for the design of circuit breaker ratings, arc-flash studies, etc., as the fault current limits must be considered so that the power equipment connected in a system do not get damaged in the worst case scenarios [38]. For example, regarding the requirements for power system protection (i.e. overcurrent and earth fault), knowledge of the expected fault levels at a protection relaying point is needed for the correct operation and co-ordination of back-up protection relays. Thus, knowledge of the network topology determining the source impedance in each type of network is essential.

C. UK-Generic Power Supply Network Impedances

It is also common practice to represent the MVA fault level at a specific network location as its equivalent Thevenin's impedance, especially in networks with a high X/R ratio (i.e. with values around 10 or above). In that situation, in order to simplify the analysis, the system's impedance value ($Z_{location}$) is assumed equal to the reactance value ($X_{location}$) of the

equivalent Thevenin's impedance, with the resistive component ($R_{location}$) usually neglected. However, the values of X/R ratios in power systems widely vary, depending on the supply voltage level (i.e. transmission or distribution), according to the differing network's strengths, changing system configurations and short-circuit capacities [39]. As shown by the results provided in Table VII (from highly-urban 11 kV networks, down to rural LV systems), the values of X/R ratios in UK power distribution networks may range from 16.42 (for 209 MVA) to 0.39 (0.28 MVA) respectively.

In addition, the results obtained for the maximum public supply impedance ($Z_{LV\ CSP}$) at the LV CSP level (last two columns in Table VII) can be directly compared with the range of values provided for UK supply systems, in ohms, in Table 1 of the IEC technical report 60725:2012 [15]. These values are provided in Table IX in the form of maximum percentiles (e.g. 98% or 90%), defining the percentage of residential customers having supply impedances equal to or less than the complex values listed in [15].

TABLE IX
UK RESIDENTIAL CONSUMERS' COMPLEX SUPPLY IMPEDANCE FOR 1-PH CONNECTIONS AT 50 HZ [15]

Country	Percentage of consumers with supply impedances equal to or less than the listed complex values	
	98%	90%
United Kingdom	$0.46 + j0.45 \Omega$	$0.25 + j0.23 \Omega$

Therefore, the 'maximum threshold' values provided in [15], which simply provides an upper boundary for all types of distribution systems and residential customer connections up to the PCC, can now be disaggregated and classified according to the supplying network type. This will assist DNOs, particularly in the UK, in determining a practical value of the actual supply impedance at a particular consumers' premises and to assist manufacturers in assessing the marketability of their products. By application of the aforementioned method, Fig. 8 presents the disaggregated modulus values, in ohms, of $Z_{LV\ CSP}$ for the four UK generic networks against the maximum thresholds (i.e. 98% and 90% probability of occurrence) provided in the IEC 60725 report [15].

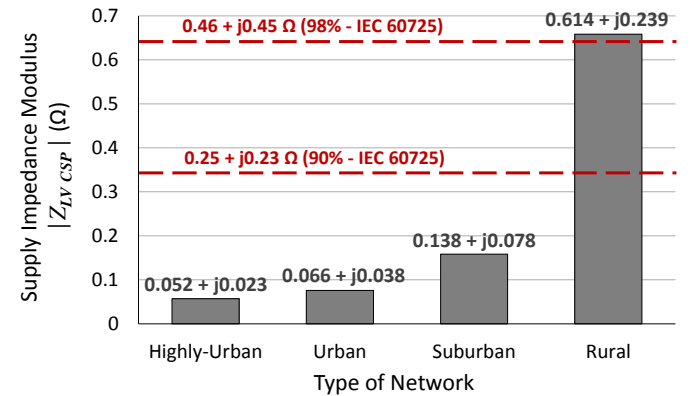

Fig. 8. Disaggregation of supply impedance maximum values, in [15], for UK-generic residential distribution networks.

According to the results in Fig. 8, the maximum source impedance value is obtained for the UK rural networks, with a modulus of $|Z_{LV_CSP}| = 0.658 \Omega$. This value is a very good match of the measured 98% percentile values, suggesting that only 2% of residential consumers (probably supplied by rural networks) are likely to have a supply system impedance greater than the corresponding modulus from Table IX of $|Z_{LV_CSP}| = 0.643 \Omega$. Below these probability thresholds, the presented methodology allows to estimate a benchmark Z_{LV_CSP} value for the other three UK-generic distribution networks. Each subsector's maximum value will act as a limiting threshold for the following subsector.

These reference impedances could be used, for example, to assess the emissions of equipment against voltage limits with a view to ensuring that connection of equipment to different public supply networks would not cause any undue voltage disturbance and distortion [16]-[18]. Moreover, the disaggregated benchmark values can benefit fault current calculation methods and PQ network studies as e.g. in [40]-[42]. However, it must be noted that the values calculated in this paper are based on nominal values of system voltage and network equipment impedances (e.g. transformers at nominal taps), but the proposed method can always be adapted to the stipulated factors in [40] to allow for voltage variations in the system, and for related studies such as motor connection (causing voltage drop) or capacitor energisation (voltage rise).

For comparison, an extensive set of case studies has also been presented in [43] for Finnish distribution networks. In that study, the highly-urban, urban and suburban networks are in line with those presented in this paper, but for rural networks, [43] presents even lower fault levels and smaller ratings of lines and transformers. This can be explained by the extremely light loads connected in those rural areas in Finland.

VI. CONCLUDING REMARKS

This paper presents a general calculation method for the benchmark values characterising typical network strengths, fault levels and source impedances at different points of the MV-to-LV distribution system. Generic network models are thoroughly described and calculated for quality of supply analysis in four residential load subsectors by using network arrangements and power components typically operated by UK/European DNOs. Moreover, the latest edition of the IEC 60725 Standard is further complemented and used as a source of validation. The range of complex values calculated for network supply impedances are compared against the single-reference threshold stipulated in IEC 60725 for UK residential consumers, which now can be further disaggregated and classified according to network/demand type.

The network modelling approach, as opposed to the measurement and survey method presented in IEC 60725, not only would it be a valuable input to future revisions of the Technical Report, but it also offers a wider applicability as it can be further reproduced in many other 230/400 V 50 Hz systems all around the world. There is currently no general methodology in existing literature aimed at identifying how

system configuration, power components, feeder structures, etc. change in different types of networks (i.e. from highly-urban to rural areas). Thus, the aim of this paper is to provide a 'general framework' that can be flexibly adapted and modified according to different system characteristics worldwide.

Since the measurement based approach in [15] would not always be feasible, and thus it is used to derive a percentile figure relevant to all similar networks, this paper presents an alternative general technique for determining the impact of supply impedance values. Furthermore, the analysis is expanded to assess the gradient of fault level variations, according to diverse feeder structures, which is directly relevant to a wide range of generic distribution networks. This approach reduces the uncertainty arising from diverse information about e.g. supply capacities, protective devices or network configurations, as well as the potential cost from expensive statistical surveys providing too specific results only. Further work will apply the assessed values in quality of supply studies to further investigate the applicability and benefits of the presented analysis.

VII. REFERENCES

- [1] M. MacDonald, "Renewables Network Impact Study Annex 3: Distribution Network Topography Analysis," The Carbon Trust & DTI, Tech. Rep., November 2003.
- [2] "Primary Network Design Manual," E-ON Central Networks plc, Tech. Rep., October 2007.
- [3] I. Hernando-Gil, B. Hayes, A. Collin, and S. Djokic, "Distribution network equivalents for reliability analysis. Part 1: Aggregation methodology," in *Innovative Smart Grid Technologies Europe (ISGT EUROPE), 2013 4th IEEE/PES*, 2013, pp. 1–5.
- [4] "E-ON Central Networks plc, Long term development statement," Central Networks West, Tech. Rep., 2009.
- [5] "Long term development statement for Scottish hydro electric power distribution plc's electricity distribution system," Scottish and Southern Energy Power Distribution, Tech. Rep., November 2009.
- [6] "Distribution long term development statement for the year 2011/12 to 2015/16," SP Distribution and SP Manweb, Tech. Rep., Nov. 2011.
- [7] "Long Term Development Statement," Electricity North West plc, Tech. Rep., 2010.
- [8] "Long Term Development Statement for the Electricity Distribution System of South Wales & South West," Western Power Distribution plc, Tech. Rep., April 2010.
- [9] "Long Term Development Statement," EDF Energy Networks, Tech. Rep., 2009.
- [10] "Long Term Development Statement," CE Electric UK, Tech. Rep., 2009.
- [11] C. Foote, P. Djapic, G. Ault, J. Mutale, and G. Strbac, "United Kingdom Generic Distribution System (UKGDS), Typical UK Distribution Networks," DTI Centre for Distributed Generation and Sustainable Electrical Energy, Tech. Rep., July 2005.
- [12] —, "United Kingdom Generic Distribution System (UKGDS), Review of Long Term Development Statements," DTI Centre for Distributed Generation and Sustainable Electrical Energy, Tech. Rep., June 2005.
- [13] "DRAKA Product Range, Cable Specifications," DRAKA UK Limited, Tech. Rep., 2010. [Online]. Available: www.drakauk.com
- [14] "Cable Specifications," NKT Cables, NKT Cables Product Catalogue. [Online]. Available: www.nktcables.cz
- [15] "Consideration of reference impedances and public supply network impedances for use in determining disturbance characteristics of electrical equipment having a rated current ≤ 75 A per phase," BSI, IEC Technical Report IEC/TR 60725, 2012.
- [16] "Electromagnetic compatibility (EMC) – Part 3-3: Limits – Limitation of voltage changes, voltage fluctuations and flicker in public low-voltage supply systems, for equipment with rated current ≤ 16 A per

- phase and not subject to conditional connection,” IEC Technical Report 61000-3-3, 2013.
- [17] “Electromagnetic compatibility (EMC) – Part 3-11: Limits – Limitation of voltage changes, voltage fluctuations and flicker in public low-voltage supply systems. Equipment with rated voltage current ≤ 75 A and subject to conditional connection,” IEC Technical Report 61000-3-11, 2001.
- [18] “Electromagnetic compatibility (EMC) – Part 3-12: Limits – Limits for harmonic currents produced by equipment connected to public low-voltage systems with input current > 16 A and ≤ 75 A per phase,” IEC Technical Report 61000-3-12, 2011.
- [19] J. Ribeiro and F. Lange, “A new aggregation method for determining composite load characteristics,” *Power Apparatus and Systems, IEEE Transactions on*, no. 8, pp. 2869–2875, 1982.
- [20] A. Collin, I. Hernando-Gil, J. Acosta, and S. Djokic, “An 11 kV steady state residential aggregate load model. Part 1: Aggregation methodology,” in *PowerTech, 2011 IEEE Trondheim*, 2011, pp. 1–8.
- [21] H. Joshi, *Residential, Commercial and Industrial Electrical Systems: Network and installation*. Tata McGraw-Hill Education, 2008, vol. 2.
- [22] E. Lakervi and E. J. Holmes, *Electricity distribution network design*, 2nd ed., ser. 21, P. P. Ltd., Ed. IEE Power Engineering, 2003.
- [23] I. Hernando-Gil, I. Ilie, and S. Djokic, “Reliability performance of smart grids with demand-side management and distributed generation/storage technologies,” in *Innovative Smart Grid Technologies (ISGT Europe), 2012 3rd IEEE/PES*, 2012, pp. 1–8.
- [24] S. Papathanassiou, N. Hatziaargyriou, K. Strunz et al., “A benchmark low voltage microgrid network,” in *Proceedings of the CIGRE Symposium: Power Systems with Dispersed Generation*, 2005, pp. 1–8.
- [25] “Information to assist third parties in the design and installation of secondary substations for adoption or use by SSE Power Distribution,” SSE Power Distribution, Tech. Rep., November 2007.
- [26] S. Y. TOLEDANO, *Técnicas y procesos en las instalaciones eléctricas en media y baja tensión*. Editorial Paraninfo, 2007 (in Spanish).
- [27] “Long term development statement,” Gas Natural Fenosa Distribution plc, Spain, Tech. Rep., 2001.
- [28] *Electricity Safety, Quality and Continuity Regulations 2002*, UK Statutory Instruments Std. 2665, January 2003.
- [29] G.B. Jasmon, and L.H.C.C. Lee, “Distribution network reduction for voltage stability analysis and loadflow calculations,” *Int. Journal of Electrical Power & Energy Systems*, Vol. 13, Issue 1, 1991, Pages 9–13.
- [30] P. Trichakis, P. C. Taylor, P. F. Lyons and R. Hair, “Predicting the technical impacts of high levels of small-scale embedded generators on low-voltage networks,” in *IET Renewable Power Generation*, vol. 2, no. 4, pp. 249–262, 2008.
- [31] G. Heydt, “Thevenin’s theorem applied to the analysis of polyphase transmission circuits,” in *IEEE Transactions on Power Delivery*, vol. PP, no.99, pp.1-1, 2016.
- [32] X. Mou, W. Li and Z. Li, “A preliminary study on the Thevenin equivalent impedance for power systems monitoring,” *Electric Utility Deregulation and Restructuring and Power Technologies (DRPT), 2011 4th International Conference on*, Shandong, 2011, pp. 730–733.
- [33] M. Patsalides, G. E. Georghiou, A. Stavrou and V. Efthymiou, “Thevenin equivalent circuit for the study of high photovoltaic penetration in distribution grids,” *IEEE PES ISGT Europe 2013*, Lyngby, 2013, pp. 1–5.
- [34] A. Saltelli, K. Chan and E. M. Scott, *Sensitivity Analysis*. Vol. 1. New York: Wiley, 2000.
- [35] Felisa J. Vázquez-Abad. “A course on sensitivity analysis for gradient estimation of des performance measures.” *Discrete Event Systems*, Vol. 569, pp 3-28. Springer US, 2000.
- [36] A. Collinson, F. Dai, A. Beddoes, J. Crabtree, “Solutions for the connection and operation of distributed generation,” DTI New and Renewable Energy Programme, Report K/EL/00303/00/01/REP, 2003.
- [37] X. Wu, N. Jenkins, G. Strbac, J. Watson, C. Mitchell, “Integrating renewables and CHP into the UK electricity system,” Tyndall Centre Technical Report 13, 2004.
- [38] Thekla N. Boutsika, Stavros A. Papathanassiou, “Short-circuit calculations in networks with distributed generation,” *Electric Power Systems Research*, vol. 78, pp. 1181–1191, issue 7, July 2008.
- [39] Ying-Pin Chang, Chi-Jui Wu, “Effect of utility system X/R ratio on harmonic amplification characteristics of a plastic plant,” in *Transmission and Distribution Conference and Exposition, 2003 IEEE PES*, vol.1, pp.68–72, vol.1, Sept. 2003.
- [40] “Short-circuit currents in three-phase a.c. systems—Part 1: factors for the calculation of short-circuit currents according to IEC 60909-0,” IEC Technical Report 60909-1, 2002.
- [41] M. Aigner, E. Schmutzger and C. Sigl, “Fault loop impedance determination in low-voltage distribution systems with non-linear sources,” *IEEE PES ISGT Europe 2013*, Lyngby, 2013, pp. 1–5.
- [42] I. Zamora, A. J. Mazon, K. J. Sagastabeitia and J. J. Zamora, “New Method for Detecting Low Current Faults in Electrical Distribution Systems,” in *IEEE Transactions on Power Delivery*, vol. 22, no. 4, pp. 2072–2079, Oct. 2007.
- [43] M. Hyvärinen, “Electrical networks and economies of load density”, PhD thesis, Helsinki University of Technology, TKK Dissertations 146, Espoo, December 2008.

Ignacio Hernando-Gil (S’10–M’14) received the B.Eng. degree in industrial engineering from Polytechnic University of Madrid, Spain, in 2008, the M.Sc. degree in energy from Heriot-Watt University, Edinburgh, U.K., in 2009, and the Ph.D. degree in power systems from the University of Edinburgh, Scotland, U.K., in 2014. He is currently a Prize Fellow at the University of Bath, England, U.K. He has also worked as a Research Fellow at the University of Edinburgh, and in industry with PassivSystems Ltd. and National Grid UK. His main research interests are in the areas of reliability planning and quality of supply in low-carbon electricity networks.

Heng Shi (S’16) was born in Hunan province, China. He received the B.Eng. degree in computer science and technology from Tsinghua University, Beijing, China, in 2013. He is currently working as a Ph.D. candidate at the University of Bath. His major research interest is the big data analysis and its application in power systems, especially in LV distribution networks.

Furong Li (SM’09) was born in Shanxi province, China. She received the B.Eng. degree in electrical engineering from Hohai University, Nanjing, China, in 1990 and the Ph.D. degree from Liverpool John Moores University, Liverpool, U.K., in 1997. She is a Professor in the Power and Energy Systems Group, University of Bath, U.K. Her major research interest is in the area of power system planning and power system economics.

Sasa Djokic (M’05–SM’11) received the Dipl. Ing. And M.Sc. degrees in electrical engineering from the University of Nis, Nis, Serbia, and the Ph.D. degree in the same area from the University of Manchester Institute of Science and Technology (UMIST), Manchester, U.K. From 1993 to 2001, he was with the Faculty of Electronic Engineering of the University of Nis. From 2001 to 2005, he was with the School of Electrical and Electronic Engineering at the UMIST/Univ. of Manchester. Currently, he is a Reader in the School of Engineering, University of Edinburgh, Scotland, U.K.

Matti Lehtonen (M’11) received the M.S. and Licentiate degrees in electrical engineering from Aalto University (formerly Helsinki University of Technology), Espoo, Finland, in 1984 and 1989, respectively, and the D.Sc. degree from Tampere University of Technology, Tampere, Finland, in 1992. Since 1987, he has been with VTT Technical Research Centre of Finland, Espoo, and since 1999, he has been with the Department of Electrical Engineering, Aalto University, where he is a Professor of information technology applications in power systems.