



*Citation for published version:*

Güngör, S, Delgado-Charro, MB, Ruiz-Perez, B, Schubert, W, Isom, P, Moslem, P, Patane, MA & Guy, RH 2010, 'Trans-scleral iontophoretic delivery of low molecular weight therapeutics', *Journal of Controlled Release*, vol. 147, no. 2, pp. 225-231. <https://doi.org/10.1016/j.jconrel.2010.07.107>

*DOI:*

[10.1016/j.jconrel.2010.07.107](https://doi.org/10.1016/j.jconrel.2010.07.107)

*Publication date:*

2010

[Link to publication](https://doi.org/10.1016/j.jconrel.2010.07.107)

©Elsevier. The original publication is available from: <http://dx.doi.org/10.1016/j.jconrel.2010.07.107>

**University of Bath**

**Alternative formats**

If you require this document in an alternative format, please contact:  
[openaccess@bath.ac.uk](mailto:openaccess@bath.ac.uk)

**General rights**

Copyright and moral rights for the publications made accessible in the public portal are retained by the authors and/or other copyright owners and it is a condition of accessing publications that users recognise and abide by the legal requirements associated with these rights.

**Take down policy**

If you believe that this document breaches copyright please contact us providing details, and we will remove access to the work immediately and investigate your claim.

## **Trans-scleral iontophoretic delivery of low molecular weight therapeutics**

**Sevgi Güngör<sup>a,1</sup>, M. Begoña Delgado-Charro<sup>a</sup>, Begoña Ruiz-Perez<sup>b</sup>, William Schubert<sup>b</sup>,  
Phil Isom<sup>b</sup>, Peyman Moslemy<sup>b</sup>, Michael A. Patane<sup>b</sup>, Richard H. Guy<sup>a,c</sup>**

<sup>a</sup>Department of Pharmacy & Pharmacology, University of Bath, Claverton Down, Bath, BA2 7AY, UK

<sup>b</sup>Eyegate Pharmaceuticals, Inc., Waltham, MA 02453, USA

<sup>c</sup>To whom correspondence should be addressed

<sup>1</sup>Present address: Department of Pharmaceutical Technology, Faculty of Pharmacy, Istanbul University, 34116, Istanbul, Turkey

### **All contributing authors of the manuscript:**

#### **Dr. Sevgi Güngör**

Department of Pharmaceutical Technology, Faculty of Pharmacy, Istanbul University, 34116, Istanbul, Turkey

E-mail: sgungor@istanbul.edu.tr

#### **Dr. M. Begoña Delgado-Charro**

Department of Pharmacy & Pharmacology, University of Bath, Claverton Down, Bath, BA2 7AY, UK

E-mail: B.Delgado-Charro@ath.ac.uk

#### **Dr. Begona Ruiz-Perez**

Eyegate Pharmaceuticals, Inc., Waltham, MA 02453, USA

E-mail: bruiz@eyegatepharma.com

#### **Dr. William Schubert**

Eyegate Pharmaceuticals, Inc., Waltham, MA 02453, USA

E-mail: wschubert@eyegatepharma.com

#### **Mr. Phil Isom**

Eyegate Pharmaceuticals, Inc., Waltham, MA 02453, USA

E-mail: pisom@eyegatepharma.com

**Dr. Peyman Moslemy**

Eyegate Pharmaceuticals, Inc., Waltham, MA 02453, USA

E-mail: pmoslemy@eyegatepharma.com

**Dr. Michael A. Patane**

Eyegate Pharmaceuticals, Inc., Waltham, MA 02453, USA

E-mail: mpatane@eyegatepharma

**Prof. Richard H. Guy** (corresponding author)

University of Bath, Department of Pharmacy & Pharmacology, Claverton Down, Bath, BA2 7AY, UK

Tel: +44 1225 384901; Fax: +44 1225 386114; Email: r.h.guy@bath.ac.uk

## GRAPHICAL ABSTRACT

Transscleral delivery of timolol maleate and dexamethasone phosphate, both low molecular weight compounds, was achieved with anodal and cathodal iontophoresis, respectively. Increased current doses produced proportional increases in transport. In comparison, anodal iontophoresis of vancomycin hydrochloride, a glycopeptide, exhibited a non-linear relationship with the applied iontophoretic dose.

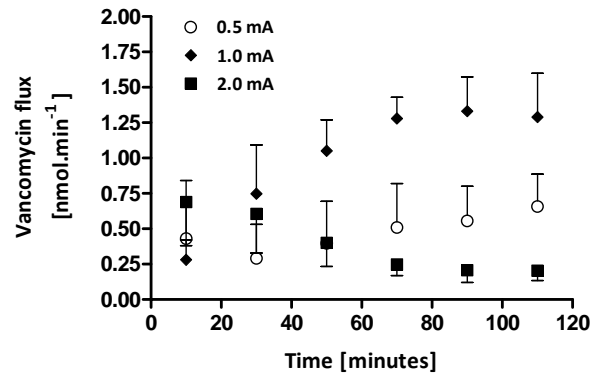
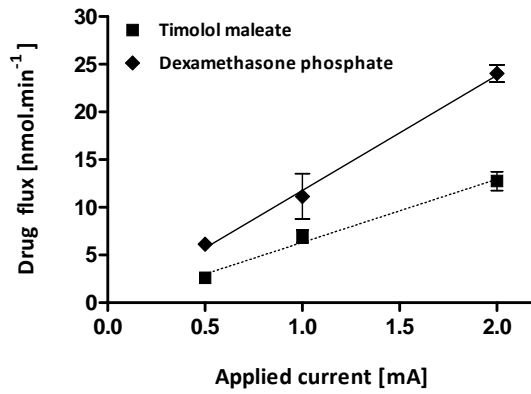

## ABSTRACT

The fundamental understanding of ocular drug delivery using iontophoresis is not at the same level as that for transdermal electrotransport. Research has therefore been undertaken to characterise the electrical properties of the sclera (charge, permselectivity, isoelectric point (pI)) and to determine the basics of iontophoretic transport of model neutral, cationic, and anionic species (respectively, mannitol, timolol, and dexamethasone phosphate). Like the skin, the sclera supports a net negative charge under physiological pH conditions and has a pI between 3.5 and 4. Equally, the principles of trans-scleral iontophoretic transport of low molecular weight compounds are consistent with those observed for skin. Iontophoretic delivery of timolol and dexamethasone phosphate was proportional to applied current and drug concentration, and trans-scleral iontophoresis in rabbits led to enhanced intraocular levels of these compounds compared to passive delivery. The behaviour of higher molecular weight species such as peptide drugs and other biopharmaceuticals (e.g., proteins and oligonucleotides) has not been fully characterised. Further work has been undertaken, therefore, to examine the trans-scleral iontophoresis of vancomycin, a glycopeptide antibiotic with a relatively high molecular weight of 1448 Da. It was indeed possible to deliver vancomycin by iontophoresis but trans-scleral transport did not increase linearly with either increasing current density or peptide concentration.

Keywords: ocular iontophoresis; trans-scleral; timolol; dexamethasone phosphate; vancomycin

## INTRODUCTION

Drug delivery to the eye to treat ocular disease principally involves either multiple topical application of formulations to the ocular surface, or injections directly into the ocular tissues (i.e. intra-vitreous, sub-conjunctival). The former is characterised by very low efficiency, in that only a few percent of the applied dose is ever absorbed [1-3], while the invasive nature of the latter approach is very clear [4-6]. Identification of an alternative method, which can deliver drugs to various compartments of the eye (from the ocular surface to the very back of the eye) would constitute an important development and satisfy obvious unmet medical need. Iontophoresis is a technique that has been examined in-depth with respect to transdermal drug delivery and has been shown capable of transporting chemicals of widely divergent properties across the skin at levels that are impossible to attain by passive diffusion [7]. In particular, iontophoresis has expanded the range of transdermal drug candidates to include charged and water-soluble species as well as allowing peptides of molecular weights greater than 1000 Daltons to be delivered. Enhanced transdermal transport induced by iontophoresis involves mechanisms whereby the applied electrical field acts on the molecule without causing detrimental perturbation of the tissues, and the correlation demonstrated between applied current and drug flux offers a means to precisely and flexibly control the delivery profile. It follows, therefore, that there is potential to explore and exploit applications of iontophoresis to drug delivery across other epithelial barriers, including the eye, and this opportunity constitutes the focus of the research reported in this paper.

Thus, the long-term objective is to advance the basic understanding of ocular iontophoresis [8,9]; specifically, to characterize the barrier's permselectivity and to establish structure-transport relationships. In the first part of this study, the electrotransport of neutral, cationic, and anionic compounds (mannitol, timolol, and dexamethasone phosphate, respectively) have been examined across rabbit sclera. Mannitol was used to measure electroosmosis and to determine the isoelectric point of the ocular barrier. Dexamethasone phosphate and timolol maleate, two widely used ophthalmic drugs, were chosen, respectively, as negatively- and positively-charged agents. It was a further goal to examine whether compound flux across the sclera can be optimized using the same strategies that have proven successful for skin [10] and to confirm that linear 'flux-current' relationships also apply at the higher current densities used in ocular delivery. Trans-scleral iontophoretic delivery of dexamethasone phosphate and timolol maleate was also evaluated *in vivo* in rabbits and compared to passive delivery.

While it is generally true that the transdermal electrotransport of small compounds (< 500 Da) increases linearly with current density and donor concentration [10,11], iontophoresis of certain cationic peptides has displayed a non-linear dependence upon concentration in the driving electrode chamber due, it is believed, to an association of the molecule with negatively-charged sites on the skin, altering its permselectivity and decreasing the electroosmotic contribution to transport [12]. Recently, trans-scleral iontophoresis of neutral, high molecular weight dextrans (MW between 4.4 and 120 kDa) *in vitro* has been reported [13]. However, the relationships between iontophoretic flux and either driving concentration or current were not explored.

Delivery of macromolecules (such as proteins and oligonucleotides) at therapeutically useful levels to the back of eye is a major challenge for the treatment of posterior segment diseases. To explore the feasibility of such a strategy, vancomycin, a structurally complex glycopeptide, which is positively charged at physiological pH [14], was chosen, in the second phase of this work, as a model compound to explore the efficiency of trans-scleral delivery via iontophoresis, and to evaluate if its transport depends on the applied current and/or the concentration in the anode chamber.

## EXPERIMENTAL METHODS

### Materials

[<sup>14</sup>C]-Mannitol (specific activity 200 μCi/mL) was obtained from Amersham, plc (Little Chalfont, UK). Ultima Gold XR, Hionic Fluor and Solvable were obtained from Perkin Elmer (Waltham, MA, USA). Mannitol (>98%), timolol maleate (>98%), and dexamethasone sodium phosphate (>98%) were purchased from Sigma-Aldrich Co. (Gillingham, UK). Dexamethasone phosphate (acid form) was manufactured by Dalton Chemical Laboratories (Toronto, ON, Canada). Dexamethasone-4,6 alpha, 21, 21-d4 was purchased from C/D/N Isotopes (Pointe-Claire, QC, Canada). Vancomycin hydrochloride (94.2%) was from Alexis Biochemicals (Exeter, UK). HEPES (N-2-hydroxy-ethylpiperazine-N-2-etansulfonic acid), sodium chloride, sodium dihydrogen phosphate, potassium dihydrogen phosphate, triethylamine, and Tris were supplied from Acros (Geel, Belgium). Ammonium acetate (ACS grade) was purchased from Sigma-Aldrich (St. Louis, MO, USA) and ammonium formate was supplied by Alfa Aesar (Ward Hill, MA, USA). Methanol (HPLC grade), acetonitrile (HPLC grade), and acetic acid were from Fischer Scientific (Loughborough, UK). Highly purified deionized water (resistivity >18.2 MΩ.cm) was used to prepare all solutions used for the *in vitro* experiments and for HPLC analysis. Sterile injection grade water (Baxter Healthcare, Deerfield, IL, USA) was used to prepare drug solutions for the *in vivo* studies. All other chemicals were of analytical grade.

### General

Trans-scleral iontophoresis studies were performed in side-by-side diffusion cells (PermeGear, Hellertown, PA, USA). The sclera was obtained from albino rabbit eyes (Harland, Bicester, UK), which were stored for no more than 3 days post-harvesting in PBS at 4°C before use. Scleral tissue was freed from the conjunctiva, extraocular muscles and choroid/retina. The sclera (transport area = 0.2 cm<sup>2</sup>) was clamped between the two half-cells (volume = 4 mL), with the conjunctival side facing the drug solution.

Ag/AgCl electrodes were used to deliver the constant current, which was provided by a power supply (either an APH 1000M from Kepco Inc., Flushing, NY, USA or a Yokogawa 7651 Programmable DC source, Woodburn Green, UK). Each experiment was performed at ambient temperature in at least quadruplicate, using the excised sclera from at least two different rabbits. Appropriate passive, no-current controls were also performed for all donor concentrations.

### Mannitol electrotransport

Anodal and cathodal iontophoresis was performed at 1 mA (5.1 mA/cm<sup>2</sup>). The current was applied for 2 hours with sampling of the receptor phase every 20 minutes. The donor solutions comprised 1 mM mannitol (spiked with <sup>14</sup>C) in 154 mM NaCl and buffered with 25 mM HEPES to pH 3.0, 3.5, 4.5, 5.5, 6.5 or 7.4. The pH 3.5 and 7.4 experiments were performed sequentially using the same sclera; likewise, the pH 4.5 and 6.5, and the pH 3.0 and 5.5, experiments were also carried out sequentially using the same barrier. At the end of the first half of each experiment, the donor and receptor chambers were fully emptied, cleaned, and refilled. In all cases, the receptor solution was identical to the donor solution except that it did not contain mannitol.

### Anodal trans-scleral iontophoresis of timolol maleate

Anodal iontophoresis was carried out at 1 mA (5.1 mA/cm<sup>2</sup>). Trans-scleral delivery from three donor solutions was first examined. All contained 0.25% w/v timolol maleate (3.4 mg/mL) but differed in the concentration of background (NaCl) electrolyte: 10, 77 and 154 mM. The pH of the donor solutions was 4.2 - 4.3. At the higher levels of background electrolyte, iontophoresis was performed over a 2-hour period; when the NaCl concentration was 10 mM, current was passed for only 70 minutes in total due to the consumption of chloride by the Ag/AgCl electrochemistry. In all cases, the receptor solution was phosphate-buffered saline (PBS) at pH 7.4 (140 mM NaCl). Samples (1 mL) of the receptor phase were withdrawn (and replaced with fresh buffer) every 10 minutes for 1.5 hr and then again at 2 hours and reserved for assay of timolol.

Ocular iontophoresis at the same current density as before was then assessed from donor solutions containing either 0.05, 0.25 or 0.5% w/v timolol maleate (i.e., 1.57, 7.86 and 15.7 mM, respectively), buffered to pH 7.0 with 25 mM Tris containing 77 mM NaCl. Current was again delivered for 2 hours and the receptor phase was sampled as before.

Finally, using the identical 0.5% w/v drug solution and receptor phase, the electrotransport of timolol was determined at applied currents of 0.5, 1.0 and 2.0 mA (2.55, 5.1 or 10.2 mA/cm<sup>2</sup>) using the method outlined above.

### Cathodal trans-scleral iontophoresis of dexamethasone phosphate

Cathodal iontophoresis was conducted for 1 hour using as donor solutions and applied current either (a) 0.4% w/v dexamethasone phosphate in water at 0.5, 1, and 2 mA (2.55, 5.1 or 10.2 mA/cm<sup>2</sup>), or (b) 0.1, 0.4, 1.0 and 2.0% w/v drug (corresponding, respectively, to 1.94, 7.74, 19.4 and 38.7 mM) at 1 mA (5.1 mA/cm<sup>2</sup>). The receptor solution was phosphate-buffered saline at pH 7.4. Samples (1 mL) of the receptor phase were withdrawn (and replaced with fresh buffer) every 10 minutes and reserved for assay of the drug.

### Anodal trans-scleral iontophoresis of vancomycin

The current was applied for 2 hours and the receptor phase was sampled every 20 minutes for delivered peptide. The electrodes were separated from their respective donor and receptor solutions by salt bridges to prevent peptide adsorption on Ag/AgCl. The salt bridges comprised 3% agarose in solutions of 100 mM Tris/Trizma<sup>®</sup> HCl (pH 7.0) and 25 mM Tris/Trizma<sup>®</sup> HCl (pH 7.4) for anode and cathode, respectively.

The receptor (cathode) compartment contained a solution of 25 mM Tris/Trizma<sup>®</sup> HCl normal saline buffered to pH 7.4. The background electrolyte in the anode compartment was a solution of 100 mM Tris/Trizma<sup>®</sup> HCl normal saline buffered to pH 7.0.

The effect of vancomycin concentration (0.1, 1.0, 5.0 and 10 mM) in the donor (anode) on trans-scleral delivery of the peptide was first examined at an applied current of 1 mA (5.1 mA/cm<sup>2</sup>). The impact of current on vancomycin iontophoresis was then determined at 0.5, 1, and 2 mA (2.55, 5.1 and 10.2 mA/cm<sup>2</sup>, respectively); for these experiments, the donor solution was 5 mM vancomycin in 20 mM Tris/Trizma<sup>®</sup> HCl.

### In Vivo Experiments

Female New Zealand white rabbits weighing 3.0 to 3.5 kg (Millbrook Breeding Labs, Amherst, MA, USA) were used. Animals were acclimated for at least 3 days before the study was initiated. All experiments were performed under identical environmental conditions, with adherence to the ARVO Statement for the Use of Animals in Ophthalmic and Vision Research



and with approval from EyeGate Pharmaceuticals' Institutional Animal Care and Use Committee (IACUC).

The iontophoretic delivery system consisted of an ocular applicator (Eyegate Pharmaceuticals, Waltham, MA, USA), two 1.5"x2" Tricot rectangular snap return electrodes (Pepin Manufacturing Inc., Lake City, MN, USA), a Yokogawa GS610 low-voltage DC generator (Yokogawa Corp., Newnan, GA, USA), electrical wires and connectors. The ocular applicator is annular in shape, and designed to fit over the limbus of the human eye, to allow direct transscleral delivery. The inner diameter of the applicator (14 mm) is the same diameter as the average human cornea to help facilitate centering of the device on the eye. The active contact surface area between the eye and the applicator is approximately 1 cm<sup>2</sup> and consists of soft polyurethane hydrophilic foam that serves as the reservoir for drug solution to be delivered; the foam reservoir held approximately 500 µL of drug solution. The electrode is inert and annular in shape to match the shape and size of the foam (Figure 1). In New Zealand White rabbits the device fits over the limbus similar to that in humans.

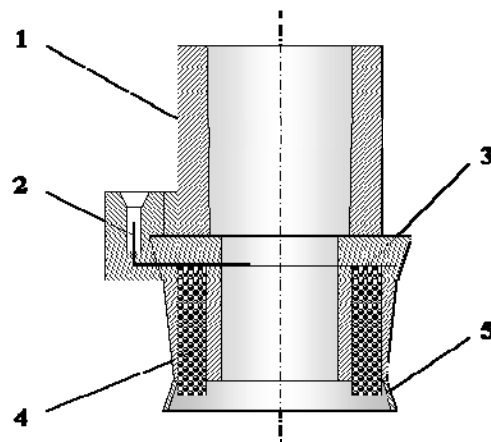

**Figure 1:** Schematic diagram of the ocular iontophoretic drug delivery device used in the *in vivo* experiments. The annular device comprises the following main elements: (1) proximal part which provides rigid support; (2) source connector pin between the current generator and the electrode; (3) electrode which transfers current to the formulation reservoir; (4) reservoir (17 mm OD x 14 mm ID x 3 mm H) which contains a polyurethane-based foam insert saturated with a solution of the drug to be delivered; and (5) distal part, which is a soft plastic that interfaces with the eye.

Animals were anesthetized by intramuscular injection of xylazine (5 mg/kg; IVX Animal Health Inc., St. Joseph, MO, USA) and ketamine (35 mg/kg; Fort Dodge Animal Health, Fort Dodge, IA, USA), and topical anesthetic (0.5% proparacaine hydrochloride; Bausch and Lomb; Rochester, NY, USA) was applied to each eye. The ocular device was loaded with the appropriate drug solution and placed on the animal's eye; two return electrodes were attached to the ears, and all were connected to the low-voltage generator. The applicator and return electrodes were disposable and discarded after each treatment.

For experiments evaluating the anodal delivery of timolol, animals received a single anodal iontophoresis dose of a 4% w/v solution of timolol maleate at 4 mA (corresponding to about 4 mA/cm<sup>2</sup>) for approximately 5 minutes (20 mA.min) (n = 4). Animals in the control group received a single drop (50 µL) of timolol maleate 4% w/v solution on each eye (n = 4). With respect to dexamethasone, animals received a single cathodal iontophoretic dose of a 4% w/v solution of dexamethasone phosphate (acid form) at 2, 4, or 6 mA (equal to approximately 2, 4 or 6 mA/cm<sup>2</sup>, respectively) for approximately 5 minutes (10, 20, and 30 mA.min respectively) (n = 3). Animals were sacrificed within 15 minutes post-treatment by intravenous overdose of

sodium pentobarbital (Euthasol<sup>®</sup>, Virbac Inc., Fort Worth, TX, USA). Ocular tissues were immediately harvested and snap frozen on dry ice. Samples were then stored at -80°C until processed.

### Analytical chemistry

Receptor phase samples from the mannitol experiments were mixed with scintillation cocktail (Ultima Gold XR, Perkin Elmer, Shelton USA) and analysed for <sup>14</sup>C in a liquid scintillation counter (Perkin Elmer, Liquid Scintillation Analyzer, Tri-Carb 2008 TR, IL, USA). The measured dpm values were transformed into a molar mannitol flux in the normal way.

Timolol maleate [15] and dexamethasone phosphate [16] were analysed by high pressure liquid chromatography (HPLC). The system comprised either a Jasco (Great Dunmow, UK) model PU-2080 Plus pump, model AS-2051 Plus autosampler, and UV detector (Model UV-2975 Plus), or a Dionex (Camberley, UK) ASI-100 automated sampler injector, P680 pump, TCC-100 thermostated column compartment, and PDA-100 diode array detector. The mobile phase for timolol maleate was a 25:75 v/v mixture of acetonitrile and an aqueous phase comprising 2.8 mL/L triethylamine and 10 mL/L acetic acid at pH 4.0. For dexamethasone phosphate, the mobile phase was 0.15 M potassium dihydrogen phosphate buffer at pH 2.0 and acetonitrile (70:30 v/v). Flow rates were 1.0 and 0.75 mL/min, and injection volumes were 20 and 25 µL, for timolol maleate and dexamethasone phosphate, respectively. Chromatographic resolution of timolol maleate and dexamethasone phosphate was performed on C18 reverse-phase columns (5 µm, 150 mm x 4.6 mm (Acclaim, UK), and 5 µm, 125 mm x 4.0 mm (HiChrom, UK), respectively), and guard columns with the same properties thermostated at 25°C. Timolol maleate and dexamethasone phosphate were determined from their UV absorbances at 294 and 240 nm, respectively. Standard stock solutions of the two compounds were prepared in methanol and appropriate dilutions were made with PBS at pH 7.4. Calibration curves were established in the ranges of 0.05 - 100 µg.mL<sup>-1</sup> ( $r^2 > 0.999$ ) and 0.02 - 100 µg.mL<sup>-1</sup> ( $r^2 > 0.999$ ) for timolol maleate and dexamethasone phosphate, respectively. Accuracy of the HPLC methods, expressed as a percentage of mean recovery, ranged from 95% to 105%, and precision had a relative standard deviation (RSD) of less than 3%. The limit of quantitation was 0.05 µg.mL<sup>-1</sup> for timolol and 0.02 µg.mL<sup>-1</sup> for dexamethasone phosphate.

Samples of the receptor phase were assayed for vancomycin [17] by HPLC (Jasco, Great Dunmow, UK). The analytical column was C18 (150 x 4.6 mm, 5 µm, Dionex) and was maintained at 30 °C. The mobile phase consisted of 5 mM potassium dihydrogen phosphate solution (pH 2.8) and acetonitrile in a ratio of 90:10. The flow rate was 1 mL/min. Vancomycin was determined from its UV absorbance at 229 nm. The relative standard deviation (RSD) of repeatability was less than 5% and the quantitation limit was 0.25 µg/mL.

### Bioanalytical Chemistry

Tissue samples were analyzed for timolol maleate content by liquid chromatography-mass spectrometry (LC-MS). The LC comprised an Agilent 1200 autosampler with a 1200 quaternary pump and column compartment (Agilent Technologies, Santa Clara, CA, USA). The MS system was an Agilent 6410 triple quadrupole operating under ElectroSpray Ionization (ESI) conditions in positive mode.

The chromatographic conditions for timolol maleate used 80:20 v/v mixture of 20 mM ammonium formate at pH 3.2 (mobile phase A) and acetonitrile/methanol (80:20 v/v) (as mobile phase B) in isocratic mode on a Waters Sunfire 3.5 µm C18, 3 x 100 mm column (Waters Corporation, Milford, MA, USA), at a flow rate of 0.8 mL/min and with an injection volume of 10 µL.

Ionization was performed in Single Ion Monitoring (SIM) mode at a  $m/z$  of 317.2 for timolol maleate in the dissociated form. Care was taken to ensure the least carryover for the system by using an injection program to limit any possible contribution from drug remaining in the injection valve. The analytical range was 0.01 - 10  $\mu\text{g}/\text{mL}$ .

All tissues except for aqueous humour and vitreous were homogenized on a Qiagen TissueLyser II (Qiagen, Valencia, CA, USA) followed by protein precipitation with acetonitrile. After centrifugation, samples were dried in a Savant SPD1010 Speedvac<sup>®</sup> (Thermo Scientific, Waltham, MA, USA) and reconstituted.

Ocular tissue samples were analyzed for dexamethasone phosphate and dexamethasone content by LC-MS/MS using a Sciex API-4000 mass spectrometer (Applied Biosystems, Foster City, CA, USA) running a Multiple Reaction Monitoring (MRM) LC-MS/MS method for simultaneous quantitation of dexamethasone and dexamethasone phosphate. Ocular tissue samples were weighed and mixed with homogenization solution (1:1 v/v MeOH:water) in a 1:9 w/v ratio and homogenized using an Omni hand-held homogenization device (Omni International, Kennesaw, GA, USA), for conjunctival tissue, or a Qiagen TissueLyser II, followed by protein precipitation with acetonitrile. Dexamethasone and dexamethasone phosphate were resolved using an ammonium acetate – methanol gradient method and a Thermo AQUASIL C18, 2.0 x 50 mm column (Thermo Scientific, Waltham, MA, USA). Standard curves of 1 ng/mL to 1000 ng/mL for both analytes were run in each tissue matrix using dexamethasone-d4 as an internal standard. Concentrations measured in ocular tissue samples were reported in nanograms per millilitre of homogenization solution for both dexamethasone and dexamethasone phosphate; data were then converted to nanomoles of dexamethasone per gram of tissue or nanomoles of dexamethasone per millilitre of aqueous humour, or to the total amount of dexamethasone delivered to each tissue compartment.

#### Data analysis

A minimum of 4 replicates was performed for each *in vitro* experiment. All results are expressed in terms of the mean  $\pm$  standard deviation. Graph Pad Prism 4.0 Software (San Diego, USA) was used for data and statistical analyses; the latter involved one-way ANOVA, followed by the Student-Newman-Keuls test. Fluxes were calculated from the slope of the cumulative amount delivered as a function of time for each replicate. A minimum of 3 replicates was performed for each *in vivo* experiment.

## RESULTS AND DISCUSSION

The passive transport of mannitol, timolol, and dexamethasone through the sclera, under all *in vitro* experimental conditions, was rather small compared to that achieved with iontophoresis (see Supplementary Table S1).

Electrotransport of mannitol *in vitro* as a function of pH is shown in the upper panel of Figure 2. At pH 7.4, transport in the anode-to-cathode direction was significantly greater than that from cathode-to-anode. At pH 3, the situation was reversed. Broadly speaking, this behaviour is not unlike skin [18], and indicates that the rabbit sclera, at physiological pH, is a net negatively-charged membrane, permselective to cations, as has been previously deduced [8] and determined for human and pig sclera [13].

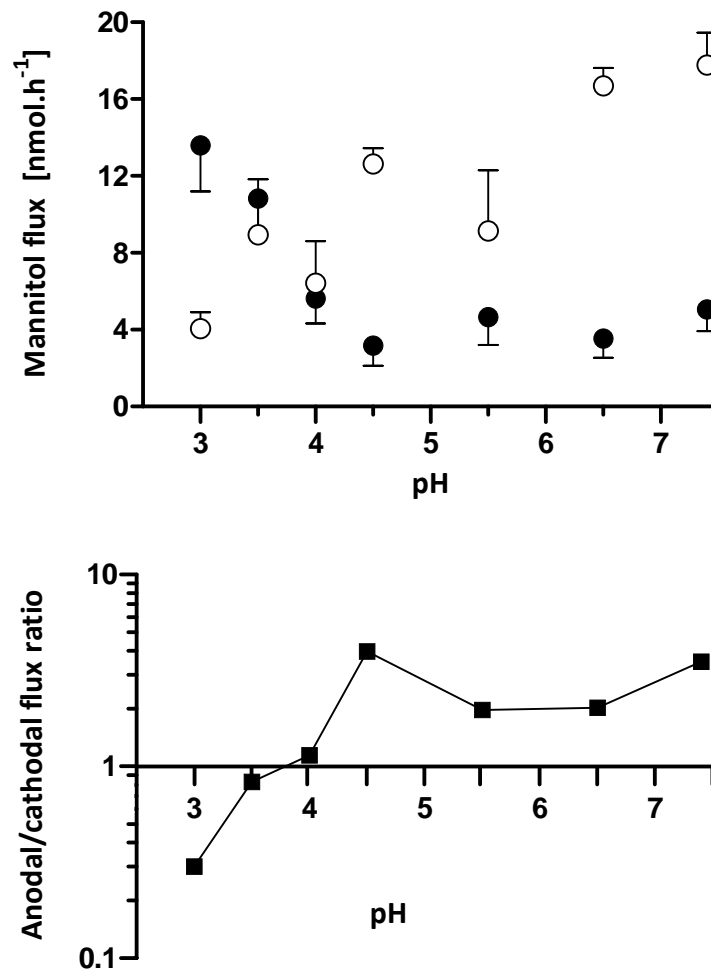

**Figure 2:** **Upper panel:** Electroosmotic flux of mannitol across rabbit sclera (area = 0.2 cm<sup>2</sup>) after 2 h of iontophoresis in the anode-to-cathode (open circles) and cathode-to-anode (filled circles) directions (mean  $\pm$  SD, n = 4).

**Lower panel:** Anodal-to-cathodal flux ratio of mannitol electroosmosis as a function of pH. The intersection of the line through the data with the x-axis indicates the approximate pI of rabbit sclera.

Based on the pH dependence of the anodal and cathodal electrotransport of mannitol, the isoelectric point (pI) of rabbit sclera is between 3.5 and 4 (Figure 2, lower panel), slightly lower than that of mammalian skin [18,19]. The deduced electroosmotic flow (= mannitol flux  $\div$

donor concentration) is  $\sim 10 \mu\text{L/h.mA}$ , a value about 6 - 7 times that observed across human skin ( $\sim 1.6 \mu\text{L/h.mA}$  under similar conditions when approximately  $1/10^{\text{th}}$  the current was applied [18] and in reasonable agreement with that which has been reported elsewhere for human and pig sclera [13]. It is noteworthy that the passive flux of mannitol across the scleral membrane is higher than that observed across skin, and this observation (which has been reported before [9]) has been attributed to the greater porosity of the ocular tissue [20].

*In vitro* iontophoresis of timolol was efficient, and the transport number of the drug was enhanced by reducing competition from the background electrolyte (Figure 3). From Faraday's law, the iontophoretic flux of the drug, and the applied current, the approximate transport numbers (calculated from the fluxes at 60 minutes of iontophoresis) of timolol from 10, 77, and 154 mM NaCl solutions (corresponding to molar fractions of drug in the three cases of 0.44, 0.09 and 0.05) were calculated to be  $5.6 (\pm 0.5)\%$ ,  $1.1 (\pm 0.03)\%$  and  $0.70 (\pm 0.04)\%$ , respectively.

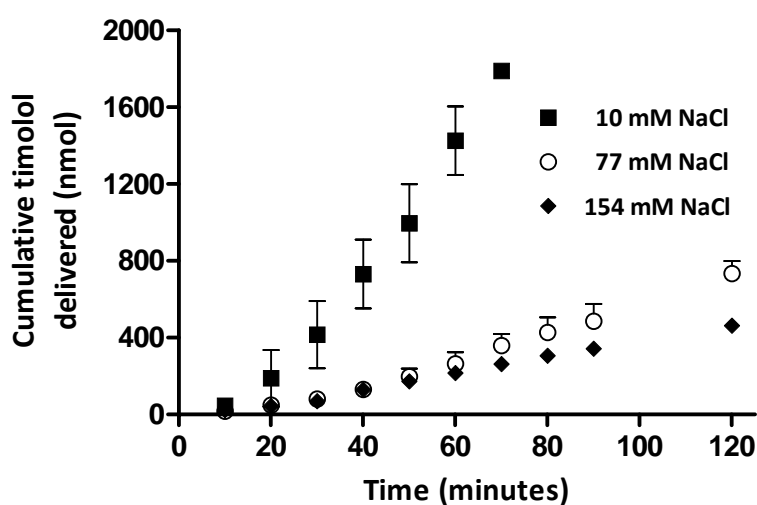

**Figure 3:** Cumulative delivery of timolol from a 0.25% w/v solution by anodal iontophoresis at 1 mA ( $5.1 \text{ mA/cm}^2$ ) as a function of time and background electrolyte concentration (mean  $\pm$  SD,  $n = 4$ ).

The experiment at the lowest NaCl concentration could not be continued for 2 hours because of chloride depletion in the anode solution. In practice, this may not pose a significant problem as the duration of ocular iontophoresis is typically much shorter.

At a fixed applied current of 1 mA, the iontophoretic delivery of timolol from a solution containing 77 mM NaCl increased linearly with drug concentration as expected (Figure 4). The fluxes at 60 minutes of iontophoresis from donor anodal solutions containing 0.05%, 0.25% and 0.50% w/v timolol maleate were  $1.4 (\pm 0.4)$ ,  $7.1 (\pm 2.3)$  and  $12.8 (\pm 0.7) \text{ nmol.min}^{-1}$ , respectively. Similarly, when the timolol concentration was held constant (0.25% w/v in 77 mM NaCl) and the applied current was allowed to increase from 0.5 to 2.0 mA, the electrotransport of the drug responded in a directly proportional fashion (Figure 5).

Unlike the somewhat linear dependence of timolol electrotransport on molar fraction, an earlier study [9] with tetraethyl ammonium chloride revealed only a 4-fold increase in transference number despite an approximately 65-fold increase in concentration of the cation. In the latter case, however, (and distinct from the situation with timolol – See Supplementary Table S1) the contribution of passive transport was rather significant [9].

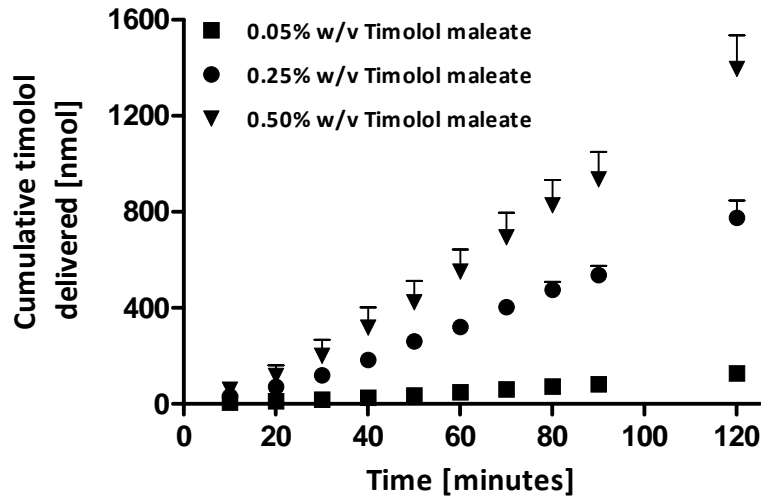

Figure 4: Cumulative delivery of timolol by anodal iontophoresis at 1 mA ( $5.1 \text{ mA/cm}^2$ ) as a function of time and concentration from solutions containing 77 mM NaCl (mean  $\pm$  SD,  $n = 4$ ).

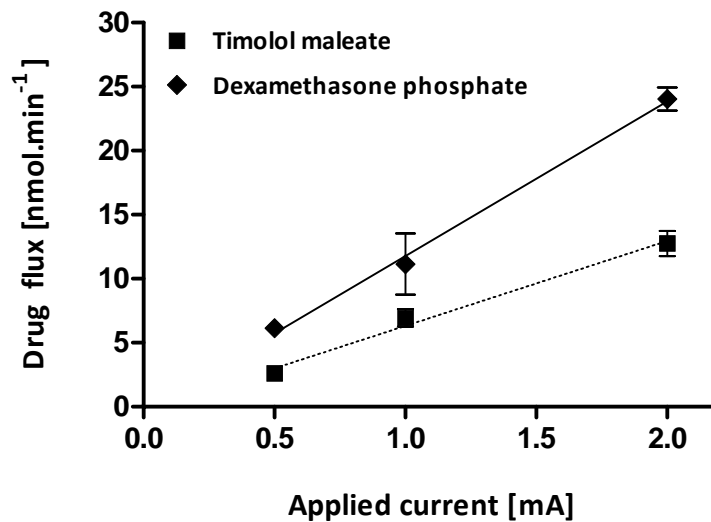
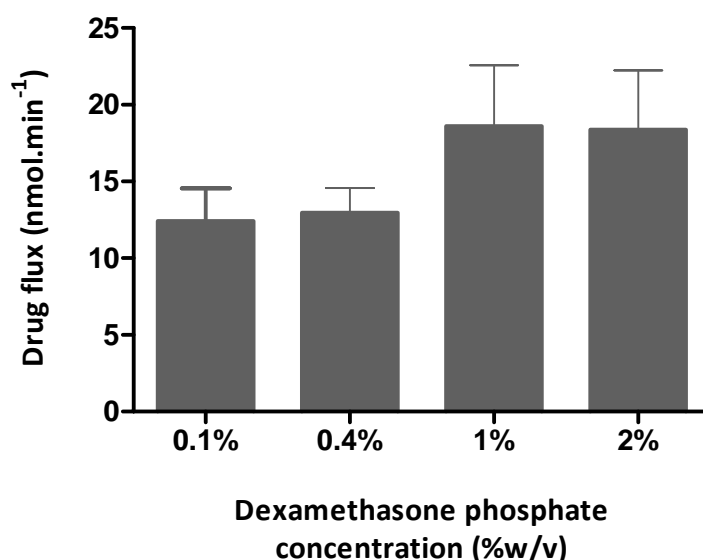

Figure 5: Steady-state iontophoretic fluxes of timolol maleate (dashed line) ( $r^2 = 0.989$ ) and dexamethasone phosphate (solid line) ( $r^2 = 0.997$ ) across rabbit sclera (area =  $0.2 \text{ cm}^2$ ) as a function of the applied current (0.5, 1.0 and 2.0 mA correspond to 2.55, 5.1 and  $10.2 \text{ mA/cm}^2$ , respectively). Timolol maleate (0.25% w/v) was delivered from a solution containing 77 mM NaCl and 25 mM Tris buffer at pH 7.0, while dexamethasone phosphate (0.4% w/v) was formulated in pure water alone (mean  $\pm$  SD,  $n = 4$ ).

*In vitro* iontophoresis of dexamethasone phosphate across the sclera was also facile, and the fluxes achieved after one hour were directly proportional to the applied current (Figure 5). This behaviour has been observed for other drugs under similar conditions (e.g., sodium salicylate [9]).

When dexamethasone phosphate was iontophored across the sclera at a fixed applied current of 1 mA ( $5.1 \text{ mA/cm}^2$ ), but from solutions of the drug at different concentrations in water (from 0.1% to 2% w/v), the fluxes after 1 hour of current passage were essentially the

same (Figure 6). In these experiments, the molar fraction of the drug in the donor, cathodal solution is effectively constant, in that there are no competing anions present. Only as iontophoresis proceeds are chloride ions 'released' into the drug solution from the Ag/AgCl electrochemistry at the cathode (and this may account for the slightly lower fluxes observed for the 0.1% and 0.4% w/v solutions). The results are in complete concordance with those recently reported on the iontophoretic delivery of dexamethasone across the skin when co-ion competition is kept to an absolute minimum [21]. The deduced transport numbers of the drug at the four concentrations considered (0.1%, 0.4%, 1% and 2% w/v) were 4.0 ( $\pm$  0.7)%, 4.2 ( $\pm$  0.5)%, 6.0 ( $\pm$  1.3)% and 5.9 ( $\pm$  1.2)%, respectively.



**Figure 6:** Iontophoretic fluxes after 1 hour of cathodal iontophoresis of dexamethasone phosphate across rabbit sclera (area = 0.2 cm<sup>2</sup>) as a function of drug concentration in pure water (mean  $\pm$  SD, n = 4).

*In vivo* iontophoresis of timolol into the eyes of rabbits (n = 4) resulted an average ( $\pm$  SD) anterior segment concentration at 15 minutes post-dosing of 160 ( $\pm$  45) nmol/mL, equivalent to a substantial (and highly significant, p < 0.01) 42-fold increase over that achieved passively with topical drops (3.9 ( $\pm$  1.7) nmol/mL). The applied current in this experiment was 4 mA (corresponding to 4 mA/cm<sup>2</sup>) for 5 minutes.

Trans-scleral cathodal iontophoresis of dexamethasone phosphate in rabbits resulted in efficient drug delivery to both the anterior and posterior segments of the eye 15 minutes post-dosing (Figure 7). Further, at all three current intensities tested, the cumulative transport of dexamethasone and dexamethasone phosphate into the four ocular tissues examined was significantly higher than that achieved by passive diffusion (ANOVA followed by the Student-Newman-Keuls test). The drug levels in the aqueous humour post-iontophoresis were 50 to 100-fold higher than those reported after topical administration of 0.1% dexamethasone phosphate (two 25  $\mu$ L drops administered 5 minutes apart) to New Zealand white rabbits [22]. The amounts of dexamethasone delivered to the vitreous humour by trans-scleral iontophoresis corresponded to concentrations well above the 0.5 - 2.5 nmol/mL range which is reported to be effective in suppressing inflammatory processes such as the production of cytokines, synthesis of prostaglandins, and migration of leukocytes [23]. These results are qualitatively consistent with an earlier investigation (also conducted *in vivo* in rabbits) of trans-scleral dexamethasone phosphate iontophoresis from a disposable hydrogel sponge [24]. In contrast, multiple topical instillations of 0.1% dexamethasone phosphate over 1 hour in the

same animal model have been shown to result in negligible levels of drug in both the vitreous humour and in the choroid-retina [25].

However, dexamethasone and dexamethasone phosphate detected within the analyzed ocular tissues in the present study was relatively insensitive, as judged by an analysis of variance, to the level of the applied current. While it is impossible to deduce an unambiguous explanation for this observation, which appears at first glance to be at odds with the *in vitro* results described earlier, it is important to point out that, even *in vitro*, the cumulative amount of dexamethasone and dexamethasone phosphate (and the deduced drug flux at 5 minutes of current passage) detected in the receive chamber is also insensitive to the applied current. It seems reasonable to suggest that endogenous ions within the tissue are perhaps responsible for carrying the majority of the current flowing in the earliest moments of iontophoresis and that only after a certain time does the electrotransport of the drug become properly proportional to the applied electrical driving force.

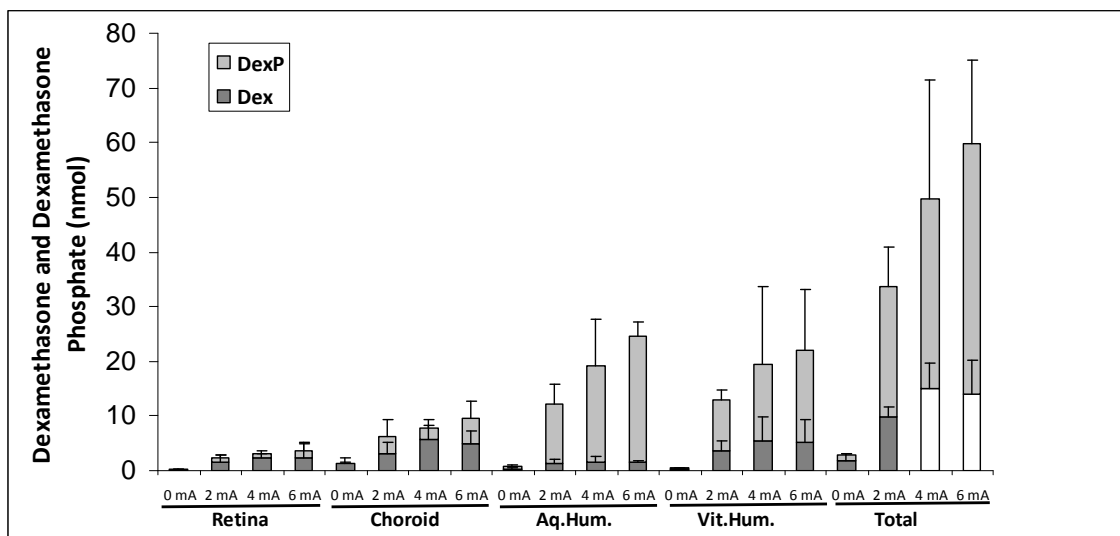
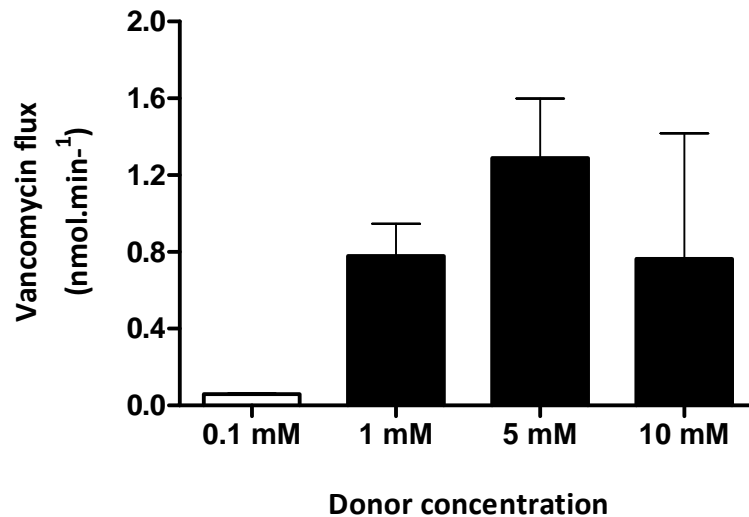

**Figure 7:** Intraocular delivery of dexamethasone and dexamethasone phosphate (expressed in nanomoles) 15 minutes after either passive delivery or cathodal trans-scleral iontophoresis (2, 4, or 6 mA (equivalent to 2, 4 or 6 mA/cm<sup>2</sup>) for 5 min of 4% w/v dexamethasone phosphate solution in New Zealand white rabbits (mean  $\pm$  SD, n = 3 for iontophoresis, n = 4 for passive delivery). The amounts of both dexamethasone and dexamethasone phosphate in each compartment were measured. "Total" corresponds to the sum of the amounts in the four tissues examined.

The passive transport of vancomycin was below the limit of quantitation under the conditions of the *in vitro* experiments performed (see Supplementary Table S2). In contrast, the passive scleral delivery of high molecular weight, neutral dextrans has recently been reported to be relatively high [13]. Vancomycin, has a net positive charge at neutral pH, rendering it unlikely to partition into the scleral membrane in the absence of an electrical driving force. With iontophoresis, the flux of vancomycin did not increase linearly with increasing concentration in the driving electrode chamber (Figure 8). While transport increased significantly by about 10-fold when the peptide concentration was raised from 0.1 to 1 mM, subsequent elevation to 5 and then 10 mM induced no further useful enhancement of flux. The flux of vancomycin after 1 hour of iontophoresis at 0.5 mA (2.55 mA/cm<sup>2</sup>) was close to one-half of that achieved when the applied current was increased to 1 mA (5.1 mA/cm<sup>2</sup>) (Figure 9). However, further increasing the current to 2 mA (10.2 mA/cm<sup>2</sup>) resulted in a dramatic decrease in electrotransport.



These behaviours have been observed in the transdermal iontophoresis of certain cationic peptides (e.g., Nafarelin and Leuprolide), and have been attributed to the association, and accumulation, of the positively-charged permeant with fixed negative charges on the membrane [12,26]. This reduces the permselectivity of the barrier to cationic species, and compromises electroosmotic flow in the anode-to-cathode direction, i.e., the principal mechanism of electrotransport for these peptides [10]. It appears that a similar phenomenon is occurring in the sclera.



**Figure 8:** *Trans-scleral, anodal iontophoretic fluxes after 2 hours (at a current of 1 mA, i.e., 5.1 mA/cm<sup>2</sup>) of vancomycin as a function of donor (anode chamber) concentration (mean ± SD, n = 4). Transport was significantly less when the drug donor concentration was 0.1 mM, but no significant differences in flux were discernible for the other three concentrations (ANOVA followed by Bonferroni post-tests (p < 0.05)).*

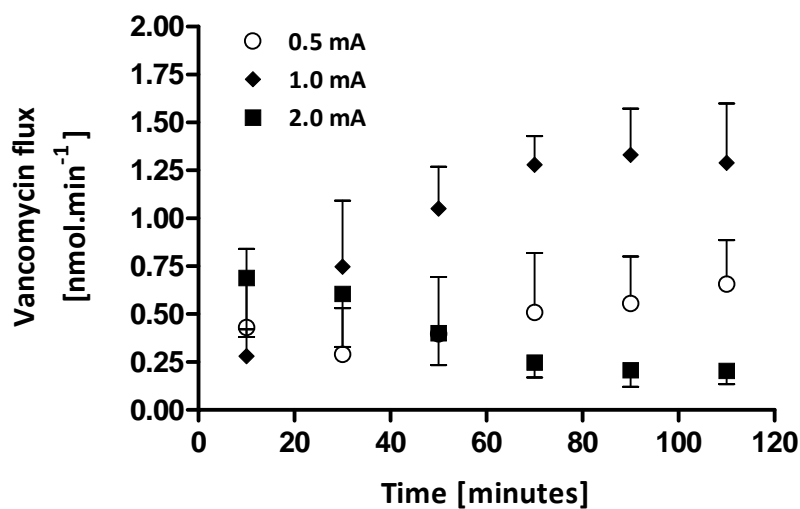

**Figure 9:** *Anodal trans-scleral iontophoretic flux of vancomycin (mean ± SD, n = 4), from a 5 mM solution in 20 mM Tris/Trizma<sup>®</sup> HCl, as a function of applied current intensity (0.5, 1.0 and 2.0 mA correspond to 2.55, 5.1 and 10.2 mA/cm<sup>2</sup>, respectively).*

## **CONCLUSIONS**

This research indicates that the results for trans-scleral iontophoresis are broadly consistent with the well-established principles for transdermal iontophoresis, and support the use of documented optimization strategies for trans-scleral drug delivery. The sclera appears to be a cation-permselective membrane, supporting a net negative charge at physiological pH. Drug transport numbers are optimized when competition from the background electrolyte is reduced. Iontophoretic fluxes are proportional to the applied current, at least for the tested small anionic and cationic drugs. Further work will explore drug structure-transport relationships and the delivery of higher molecular weight species.

Significant trans-scleral delivery of timolol, dexamethasone phosphate, and vancomycin was achieved by iontophoresis. The results from the vancomycin experiments suggest that the peptide driving concentration and the applied current need to be judiciously chosen so as to optimise transport, and to avoid complications caused by association of the permeant with the membrane itself in a manner quite similar to that observed previously for transdermal iontophoresis of certain peptides. Interestingly, it may be possible to maximise vancomycin electrotransport with a lower concentration and a lesser applied current, clear advantages for the development of a practical ocular delivery system.

## **Acknowledgements**

We thank Eyegate Pharmaceuticals, Inc., and the Istanbul University Research Fund (UDP-3787, 22052009), for financial support.

## REFERENCES

1. K. Jarvinen, T. Jarvinen, A. Urtti, Ocular absorption following topical delivery Adv. Drug Deliv. Rev. 16 (1995) 3-19.
2. N.M. Davies, Biopharmaceutical considerations in topical ocular drug delivery, Clin. Exp. Pharmacol. Physiol. 27 (2000) 558-562.
3. D. Gbate, H.F. Edelhauser, Ocular drug delivery. Exp. Opin. Drug Deliv. 3 (2006) 275-287.
4. R.D. Jager, L.P. Aiello, S.C. Patel, E.T. Cunningham, Risks of intravitreal injection: a comprehensive review, Retina 24 (2004) 676-698.
5. M.L. Reichle, Complications of intravitreal steroid injections, Optometry 76 (2005) 450-460.
6. J.B. Jonas, U.H. Spandau, F. Schlichtenbrede, Short-term complications of intravitreal injections of triamcinolone and bevacizumab. Eye (Lond) 22 (2008) 590-591.
7. M.B. Delgado-Charro, Recent advances on transdermal iontophoretic drug delivery and non-invasive sampling, J. Drug Deliv. Sci. Tech. 19 (2009), 75-88.
8. E. Eljarrat-Binstock, A.J. Domb, Iontophoresis: a non-invasive ocular drug delivery, J. Control. Release 110 (2006) 479-489.
9. S.K. Li, Y. Zhang, H. Zhu, W.I. Higuchi, H.S. White, Influence of asymmetric donor-receiver ion concentration upon transscleral iontophoretic transport, J. Pharm. Sci. 94 (2005) 847-860.
10. R.H. Guy, Y.N. Kalia, M.B. Delgado-Charro, V. Merino, A. López, D. Marro, Iontophoresis: electrorepulsion and electroosmosis, J. Control. Release 64 (2000) 129-132.
11. B. Mudry, R.H. Guy, M.B. Delgado-Charro, Iontophoresis in transdermal delivery, in: E. Touitou, B.W. Barry (Eds.), Enhancement in Drug Delivery, Taylor & Francis, New York, 2006, pp. 279-302.
12. M.B. Delgado-Charro, A.M. Rodriguez-Bayon, R.H. Guy, Iontophoresis of nafarelin: effect of current density and concentration on electrotransport *in vitro*, J. Control. Release 35 (1995) 35-40.
13. S. Nicoli, G. Ferrari, M. Quarta, C. Macaluso, P. Santi, *In vitro* transscleral iontophoresis of high molecular weight neutral compounds, Eur. J. Pharm. Sci. 36 (2009) 486-492.
14. K. Takacs-Novak, B. Noszal, M. Tokes-Kövesdi, G. Szasz, Acid-base properties and proton-speciation of vancomycin, Int. J. Pharm. 89 (1993) 261-263.
15. D.G. Fatouros, J.A. Bouwstra, Iontophoretic enhancement of timolol across human dermatomed skin *in vitro*, J. Drug Targeting 12 (2004) 19-24.
16. J.-P. Sylvestre, M.B. Delgado-Charro, R.H. Guy, *In vitro* optimization of dexamethasone phosphate delivery by iontophoresis, Phys. Ther. 88 (2008) 1-9.
17. J. Luksa, A. Marusic, Rapid high-performance liquid chromatographic determination of vancomycin in human plasma, J. Chromatogr. B 667 (1995) 277-281.
18. D. Marro, R.H. Guy, M.B. Delgado-Charro, Characterization of the iontophoretic permselectivity properties of human and pig skin, J. Control Release 70 (2001) 213-217.
19. A. Luzardo-Alvarez, M. Rodríguez-Fernández, J. Blanco-Méndez, R.H. Guy, M.B. Delgado-Charro, Iontophoretic permselectivity of mammalian skin: characterization of hairless mouse and porcine membrane models, Pharm. Res. 15 (1998) 984-987.

20. M.R. Prausnitz, J.S. Noonan, Permeability of cornea, sclera, and conjunctiva: A literature analysis for drug delivery to eye, *J. Pharm. Sci.* 87 (1998) 1479-1488.
21. J.-P. Sylvestre, C. Diaz-Marin, M.B. Delgado-Charro, R.H. Guy, Iontophoresis of dexamethasone phosphate: Competition with chloride ions, *J. Control. Release* 131 (2008) 41-46.
22. T. Krupin, S. R. Waltman, B. Becker, Ocular penetration in rabbits of topically applied dexamethasone, *Arch. Ophthalmol.* 92 (1974) 312-314.
23. C. K. Cheng, A. S. Berger, P. A. Pearson, P. Ashton, G. J. Jaffe, Intravitreal sustained-release dexamethasone device in the treatment of experimental uveitis, *IOVS*, 36 (1995) 442-453.
24. E. Eljarrat-Binstock, F. Raiskup, J. Frucht-Pery, A. Domb. Transcorneal and transscleral iontophoresis of dexamethasone phosphate in rabbits using drug loaded hydrogel. *J. Control Rel.* 106 (2005) 386-390.
25. T. T. Lam, D. P. Edward, X. A. Zhu, M. O. Tso, Transscleral iontophoresis of dexamethasone, *Arch. Ophthalmol.* 107 (1989) 1368-71.
26. A. H. Hoogstraate, V. Srinivasan, S.M. Sims, W. I. Higuchi, Iontophoretic enhancement of peptides: behaviour of leuprolide versus model permeants, *J. Control. Release* 31 (1994) 41-47.

## FIGURE LEGENDS

- Figure 1: Schematic diagram of the ocular iontophoretic drug delivery device used in the *in vivo* experiments. The annular device comprises the following main elements: (1) proximal part which provides rigid support; (2) source connector pin between the current generator and the electrode; (3) electrode which transfers current to the formulation reservoir; (4) reservoir (17 mm OD x 14 mm ID x 3 mm H) which contains a polyurethane-based foam insert saturated with a solution of the drug to be delivered; and (5) distal part, which is a soft plastic that interfaces with the eye.
- Figure 2: **Upper panel:** Electroosmotic flux of mannitol across rabbit sclera (area = 0.2 cm<sup>2</sup>) after 2 h of iontophoresis in the anode-to-cathode (open circles) and cathode-to-anode (filled circles) directions (mean ± SD, n = 4). **Lower panel:** Anodal-to-cathodal flux ratio of mannitol electroosmosis as a function of pH. The intersection of the line through the data with the x-axis indicates the approximate pI of rabbit sclera.
- Figure 3: Anodal iontophoresis at 1 mA of timolol from a 0.25% w/v solution as a function of time and background electrolyte concentration (mean ± SD, n = 4).
- Figure 4: Cumulative delivery of timolol by anodal iontophoresis at 1 mA (5.1 mA/cm<sup>2</sup>) as a function of time and concentration from solutions containing 77 mM NaCl (mean ± SD, n = 4).
- Figure 5: Steady-state iontophoretic fluxes of timolol maleate (dashed line) ( $r^2 = 0.989$ ) and dexamethasone phosphate (solid line) ( $r^2 = 0.997$ ) across rabbit sclera (area = 0.2 cm<sup>2</sup>) as a function of the applied current (0.5, 1.0 and 2.0 mA correspond to 2.55, 5.1 and 10.2 mA/cm<sup>2</sup>, respectively). Timolol maleate (0.25% w/v) was delivered from a solution containing 77 mM NaCl and 25 mM Tris buffer at pH 7.0, while dexamethasone phosphate (0.4% w/v) was formulated in pure water alone (mean ± SD, n = 4).
- Figure 6: Iontophoretic fluxes after 1 hour of cathodal iontophoresis of dexamethasone phosphate across rabbit sclera (area = 0.2 cm<sup>2</sup>) as a function of drug concentration in pure water (mean ± SD, n = 4).
- Figure 7: Intraocular delivery of dexamethasone (expressed in nanomoles) 15 minutes after either passive delivery or cathodal trans-scleral iontophoresis (2, 4, or 6 mA, (equivalent to 2, 4 or 6 mA/cm<sup>2</sup>) for 5 min of 4% w/v dexamethasone phosphate solution in New Zealand white rabbits (mean ± SD, n = 3 for iontophoresis, n = 4 for passive delivery). The amounts of both dexamethasone and dexamethasone phosphate in each compartment were measured. . "Total" corresponds to the sum of the amounts in the four tissues examined.
- Figure 8: Trans-scleral, anodal iontophoretic fluxes after 2 hours (at a current of 1 mA, i.e., 5.1 mA/cm<sup>2</sup>) of vancomycin as a function of donor (anode chamber) concentration (mean ± SD, n = 4). Transport was significantly less when the drug donor concentration was 0.1 mM, but no significant differences in flux were discernible for the other three concentrations (ANOVA followed by Bonferroni post-tests (p < 0.05).
- Figure 9: Anodal trans-scleral iontophoretic flux of vancomycin (mean ± SD, n = 4), from a 5 mM solution in 20 mM Tris/Trizma<sup>®</sup> HCl, as a function of applied current intensity (0.5, 1.0 and 2.0 mA correspond to 2.55, 5.1 and 10.2 mA/cm<sup>2</sup>, respectively).

# FIGURES

Figure 1

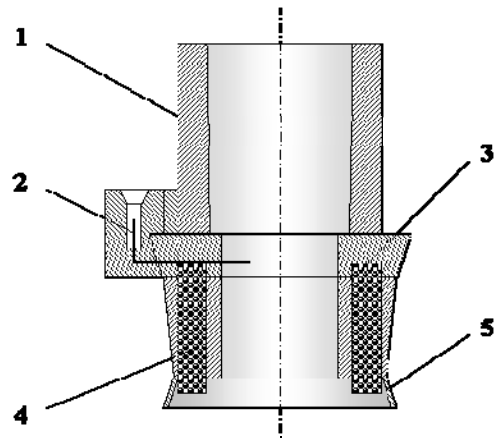

Figure 2

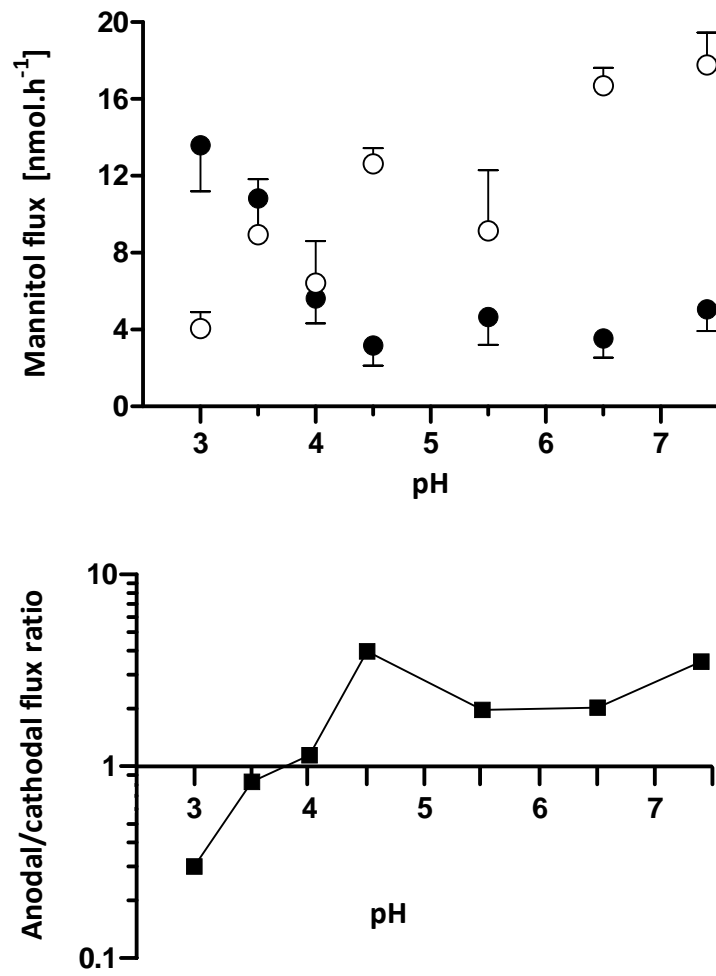

Figure 3

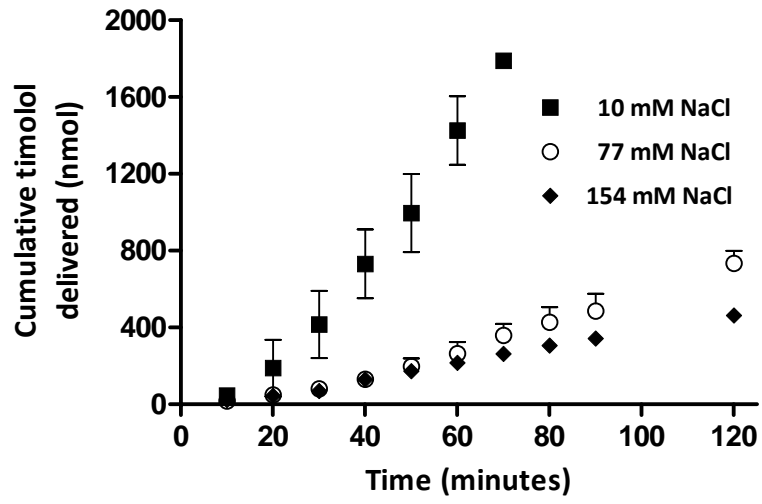

Figure 4

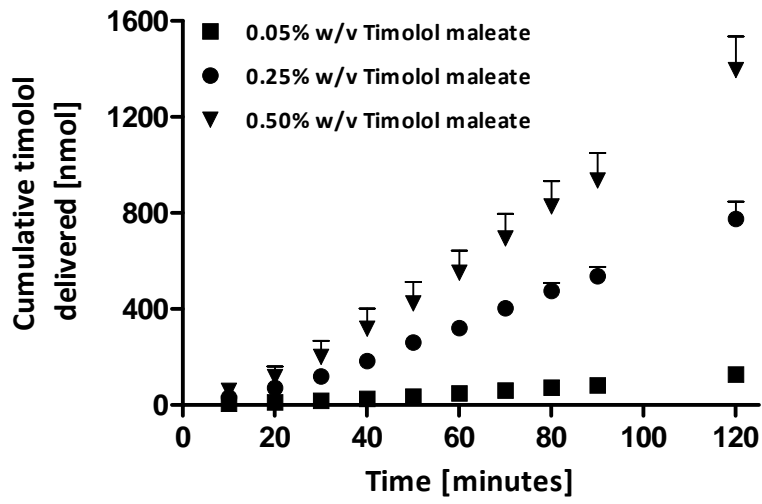

Figure 5

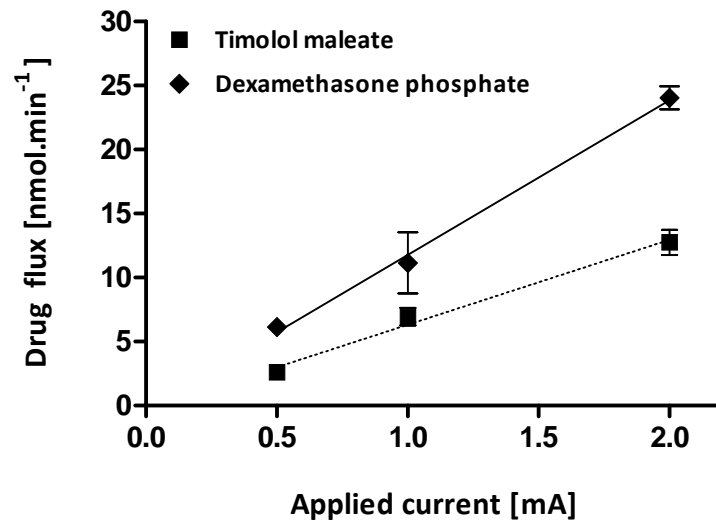

Figure 6

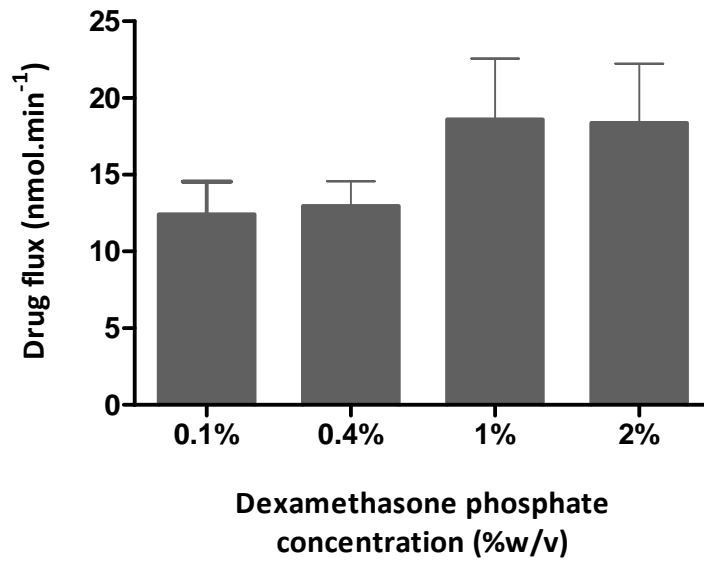



Figure 7

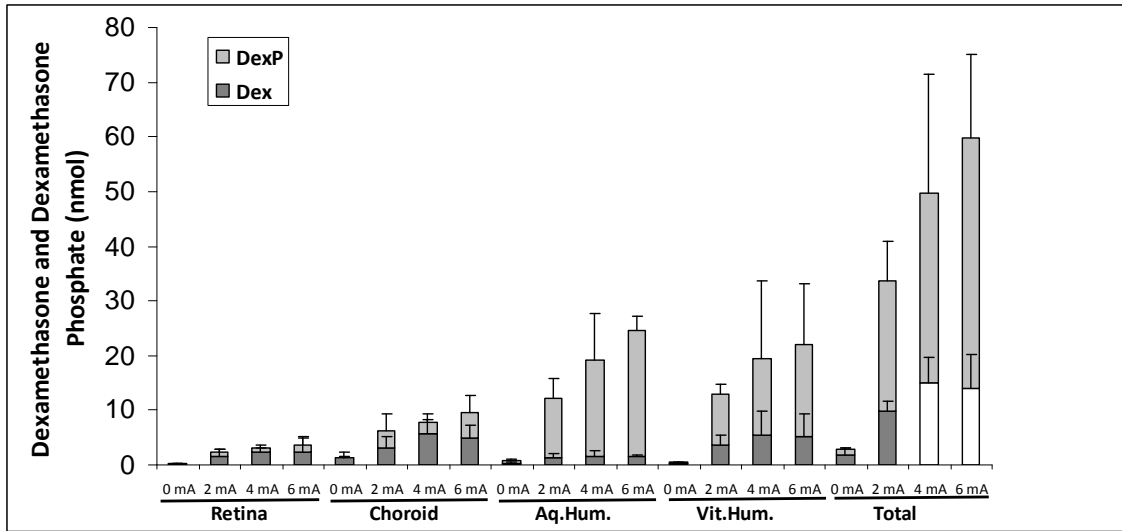

Figure 8

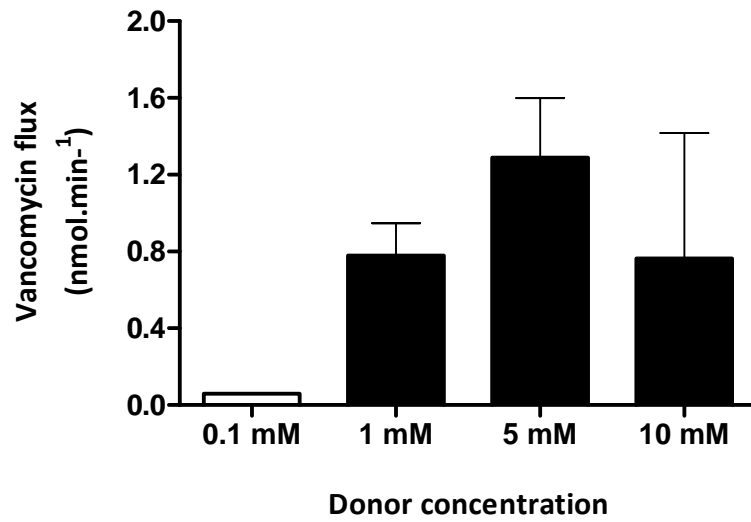
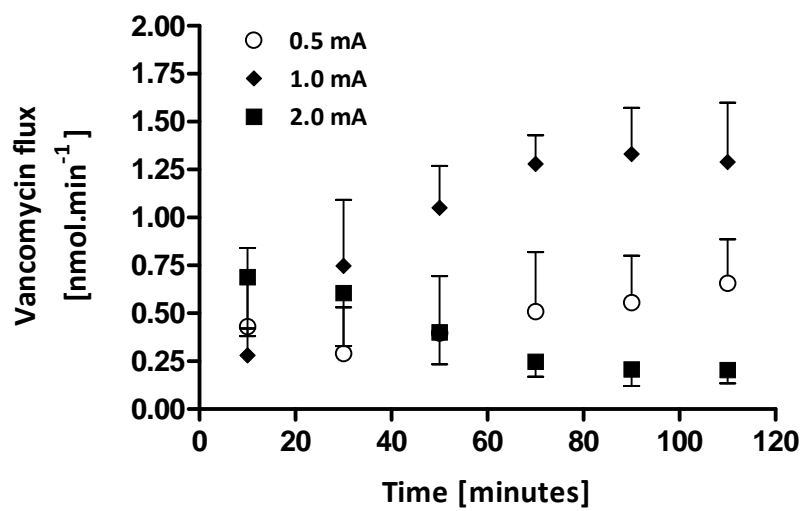

Figure 9



## Supplementary Tables

**Table S1:** Passive fluxes of mannitol, dexamethasone and timolol across rabbit sclera from various donor solutions after 120, 60 and 120minutes of transport, respectively.

Donor solution composition	Passive flux	
	nmol/min	nmol/cm <sup>2</sup> /min
Mannitol (1 mM) in 154 mM NaCl, buffered with 25 mM HEPES (pH 7.4)	0.09 ± 0.03	0.45 ± 0.14
Dexamethasone (0.1% w/v) in water (pH 7.8)	0.03 ± 0.02	0.15 ± 0.09
Dexamethasone (0.4% w/v) in water (pH 7.9)	0.21 ± 0.20	1.05 ± 0.98
Dexamethasone (1% w/v) in water (pH 7.9)	0.52 ± 0.43	2.60 ± 2.14
Dexamethasone (2% w/v) in water (pH 8.0)	0.05 ± 0.04	0.25 ± 0.20
Timolol (0.25% w/v) in 10 mM NaCl (pH 4.4)	0.45 ± 0.32	2.25 ± 1.61
Timolol (0.25% w/v) in 77 mM NaCl (pH 4.3)	0.43 ± 0.49	2.15 ± 2.50
Timolol (0.25% w/v) in 154 mM NaCl (pH 4.4)	0.37 ± 0.33	1.85 ± 1.64
Timolol (0.05% w/v) in 77 mM NaCl, buffered with 25 mM Tris (pH 7.0)	0.22 ± 0.15	1.10 ± 0.75
Timolol (0.25% w/v) in 77 mM NaCl, buffered with 25 mM Tris (pH 7.0)	0.59 ± 0.30	2.95 ± 1.50
Timolol (0.50% w/v) in 77 mM NaCl, buffered with 25 mM Tris (pH 7.0)	0.64 ± 0.51	3.20 ± 2.55

**Table S2:** Passive fluxes of vancomycin across rabbit sclera from various donor solutions after 120 minutes of transport.

Donor solution composition	Passive flux	
	nmol/min	nmol/cm <sup>2</sup> /min
Vancomycin (0.1 mM) in 100 mM Tris/Trizma <sup>®</sup> HCl (pH 7.0) buffer	-*	-*
Vancomycin (1 mM) in 100 mM Tris/Trizma <sup>®</sup> HCl (pH 7.0) buffer	0.04 ± 0.03	0.20 ± 0.15
Vancomycin (5 mM) in 100 mM Tris/Trizma <sup>®</sup> HCl (pH 7.0) buffer	0.05 ± 0.03	0.25 ± 0.14
Vancomycin (10 mM) in 100 mM Tris/Trizma <sup>®</sup> HCl (pH 7.0) buffer	0.05 ± 0.03	0.25 ± 0.15

\*not detectable