



Citation for published version:

Lawrence, M, Heath, A & Walker, P 2013, 'Development of a novel mortar for use with unfired clay bricks', *Proceedings of the Institution of Civil Engineers: Construction Materials*, vol. 166, no. 1, pp. 18-26.
<https://doi.org/10.1680/coma.11.00011>

DOI:

[10.1680/coma.11.00011](https://doi.org/10.1680/coma.11.00011)

Publication date:

2013

Document Version

Publisher's PDF, also known as Version of record

[Link to publication](#)

Permission is granted by ICE Publishing to print one copy for personal use. Any other use of these PDF files is subject to reprint fees.

University of Bath

Alternative formats

If you require this document in an alternative format, please contact:
openaccess@bath.ac.uk

General rights

Copyright and moral rights for the publications made accessible in the public portal are retained by the authors and/or other copyright owners and it is a condition of accessing publications that users recognise and abide by the legal requirements associated with these rights.

Take down policy

If you believe that this document breaches copyright please contact us providing details, and we will remove access to the work immediately and investigate your claim.

Development of a novel mortar for use with unfired clay bricks

1 **Mike Lawrence** MA, MSc, PhD
BRE Centre for Innovative Construction Materials, Bath, UK

2 **Andrew Heath** MS, PhD
BRE Centre for Innovative Construction Materials, Bath, UK

3 **Pete Walker** BSc, PhD, MIEAust, CPEng
BRE Centre for Innovative Construction Materials, Bath, UK

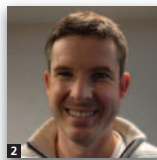

Interest in traditional unfired clay building materials, including cob, earth brick, and rammed earth, has grown in the UK in recent years. Although the use of vernacular techniques, such as cob and rammed earth, has raised the profile of earthen architecture, a wider impact on modern construction is more likely to come from modern innovations such as unfired extruded clay masonry units and premixed plasters. Traditional unfired clay walls often have basal widths of 300 mm or more, providing an inherent stability and resistance to toppling through self-weight. Masonry units extracted from UK brick production lines before the firing process are typically 100 mm wide, which requires good mortar-brick bond strength to meet structural robustness requirements in a typical 2.4 m high wall. In testing, traditional mortars based on clay, cement or lime, have not provided sufficient strength. This paper examines the bonding of unfired clay units with unconventional mortars based on novel binders. It reports on the development of a mortar which appears to be suitable for a wide range of clay types. This mortar can be readily recycled and has a carbon footprint lower than many alternative binders. Results of long-term bond strengths and the structural performance of masonry walls are given, which demonstrate the suitability of this mortar for use with unfired clay masonry units.

1. Introduction

The targets set out in the UK by the *Code for Sustainable Homes* (DCLG, 2006), the Kyoto Protocol (United Nations, 1998), the 2016 Zero Carbon Policy (DCLG, 2007) and the Low Carbon Construction Action Plan (BIS, 2011) demand reductions in the embodied carbon of building materials because they contribute 10% of the total carbon dioxide emissions for the whole of the UK across all sectors (Innovation and Growth Team, 2010; DECC, 2011). Unfired clay materials can provide a sustainable and potentially healthy alternative as a replacement to conventional masonry materials, such as fired clay and concrete block, in both non-load-bearing and low rise load-bearing applications (Morton, 2008). Although unfired clay bricks are used for external walls in Germany (Minke, 2006), their use in the UK is generally limited to internal walls (Morton, 2008). Environmental benefits include significantly reduced embodied energy; Morton (2006) demonstrated that commercially produced

extruded earth units have about 14% of the embodied carbon of fired clay bricks. They have high thermal mass, specific heat capacity approximately 1000 J/kg K (Minke, 2008), which is similar to concrete and the capacity to regulate humidity. Padfield (1998) showed unfired clay, which is hygroscopic, was the best performing common inorganic material for the regulation of internal humidity. Materials may be taken from sustainable resources such as clay which is unsuitable for fired bricks, and overburden which would form part of a clay quarry environmental management plan. Both types can be readily re-used, re-cycled or harmlessly disposed of on end use and both are also non-hazardous. Although traditional clay masonry materials, such as adobe, clay lump and cob blocks, as well as more recently developed compressed earth blocks have been used successfully in a variety of projects, increasing interest has been shown in using unfired clay bricks produced by high volume industrial brick manufacturers. The tensile strength of unfired clay materials is low and the bond between unfired clay

units and traditional clay mortars is poor, and therefore walls have relied on their self weight to ensure lateral load resistance. Consequently traditional solid walls are typically at least 250–300 mm thick. The standard size of fired clay bricks in the UK is 215 mm × 102.5 mm × 65 mm. Although the dimensions of unfired clay bricks are slightly larger, they remain smaller than adobe and compressed earth block dimensions or the sizes of solid rammed earth or cob walls.

To maximise useable floor space in a project, as well as reducing material use, designers, developers and clients demand minimal wall thicknesses. Consequently the large sizes of traditional unfired clay walls are generally not acceptable for many situations. However, thin masonry walls, approximately 105 mm thick, cannot rely on their self-weight alone to provide adequate resistance to lateral loading. Therefore, masonry bond strength is required to create a structurally robust wall that will not collapse when it experiences lateral loading. Wall thickness has a large effect on required bond strength. A 2.4 m high vertically spanning wall at 300 mm thick, even with very low bond strength (0.024 N/mm^2), can withstand a uniform pressure of 0.42 kN/m^2 . In order to reduce the thickness of the wall to 105 mm, while providing the same flexural capacity, the bond strength must be increased to around 0.2 N/mm^2 . There are many examples of single storey 300 mm thick earthen walls where the bond strength approaches zero (e.g. adobe blocks with clay mortars (Minke, 2006)). The bond strength of 0.2 N/mm^2 for a 100 mm thick wall is considered a reasonable target characteristic strength for unfired earth masonry as this is also the minimum characteristic strength for autoclaved aerated concrete with failure parallel to the bed joints, the same failure mechanism as the bond wrench, specified in Eurocode 6 (BS EN 1996-1-1: BSI (2005b)).

The test results provided herein build on previously published work (Lawrence *et al.*, 2008; Walker *et al.*, 2008) and relate to the bond strength characteristics of a novel mortar with two commercially available unfired clay bricks, shown in Figure 1.

The basic properties of the unfired bricks are summarised in Table 1.

2. Previous work

In preparation for this study the bond developed by a range of different mortars used with unfired clay bricks were assessed. Using the bond wrench methodology (see below) with the two bricks shown in Figure 1, it was found that mortars made with sand and clay; sand and cement; and sand and lime all resulted in 28 day bond strengths below 0.01 N/mm^2 , which is insufficient for the proposed application. The addition of 5% lignosulfonate to a sand and clay mortar produced an improved bond strength of 0.05 N/mm^2 , albeit still well below

that required for thin wall construction. It was found that a proprietary lignosulfonate-based mortar, marketed for use with the Ecobrick, performed poorly when used with the Ecoterre brick (with similar bond strength to sand and clay alone).

In order to produce a mortar that would be suitable for all types of unfired clay brick, other binders were assessed, and sodium silicate was found to be the most promising. Sodium silicate is widely used in earth building as sealant to improve abrasion and weather resistance (Minke, 2008). Sodium silicate mortars are also used in brickwork flues and chimneys as they are sulfate and heat resistant. As sodium silicate is water soluble, it is not recommended as a cement replacement in conventional masonry where there is a risk of wetting. However, in earth masonry in which the masonry units have limited water resistance, there is no requirement for a water-resistant mortar and adequate performance is assured through the use of appropriate detailing and use in appropriate areas (not prone to flooding).

3. Sodium silicate

Sodium silicate has the general chemical formulation of $\text{Na}_2\text{O}\cdot x\text{SiO}_2$, being a mixture of varying proportions of SiO_2 and Na_2O , and it is commonly known as water glass. It is manufactured through the hydrothermal dissolution of silica sand in sodium hydroxide to produce a sodium silicate solution of typically 48% solid and a weight ratio of 2 (2 parts SiO_2 to 1 part Na_2O). The energy requirement for the production of this hydrothermal liquor is 500 MJ/tonne output (Fawer *et al.*, 1999). For comparison purposes, cement production requires about 4400 MJ/tonne output (IEA, 2007). One kilogram of sodium silicate mortar (45 : 15 : 12 ratio of sand : clay : sodium silicate) has embodied carbon of 18.2 g carbon dioxide (CO_2)-equivalent (factory gate value); 1 kg of cement mortar (1 : 2 : 9 ratio of cement : lime : sand) has embodied carbon of 155 g CO_2 -equivalent (Hammond and Jones, 2008), which is over 8.5 times the embodied carbon. Table 2 shows the embodied carbon for the constituent parts of the mortars taken from the Inventory of Carbon and Energy (ICE) (Hammond and Jones, 2008).



Figure 1. Unfired clay bricks used in the research

Name	Ecoterre (produced by Ibstock Brick Ltd)	Ecobrick (produced by the Errol Brick Company)
Material properties		
Liquid limit: %	29	48
Plastic limit: %	17	22
Plasticity index: %	12	26
Linear shrinkage: %	7.0	9.1
Gravel content: 2–63 mm: %	10	1
Sand content: 0.063–2 mm: %	32	13
Silt content: 0.002–0.063 mm: %	33	49
Clay content: < 0.002 mm: %	25	37
Chemical properties		
Organic content: %	0.83	1.4
pH	7.7	7.6
Acid soluble SO ₄ : %	0.054	0.03
Water soluble SO ₄ 2 : 1 extract: g/l	0.05	0.04
Water soluble chloride: mg/l	U/S	< 50
Total chloride: %	< 0.010	< 0.010
Mean unit properties		
Length: mm	226.5	222.8
Width: mm	106.8	105.6
Height: mm	66.2	66.9
Voids: %	6	21
Net dry density: kg/m ³	2021	1597
Compressive strength		
Net compressive at 20°C and 60% relative humidity: N/mm ² *	3.92	3.76

*Not corrected for sample dimensions. Heath *et al.* (2009) present information on effect of moisture content on compressive strength.

Table 1. Properties of Ecoterre and Errol bricks

When heated, excess water is driven off from sodium silicate and a glassy material is produced. At very high temperatures, it is intumescent (Otaka and Asako, 2002). These characteristics allow it to be used for passive fire protection, fire cements, automotive repairs (exhaust pipes, leaky radiators). Sodium silicate has a high pH, allowing it to be used as a buffer in detergents, and as a stabiliser in pulp and paper manufacture. It is also used in paint manufacture, as a plasticiser in the ceramics industry and as a binder and fluxing agent for welding electrodes. In construction, sodium silicate is used as a coating to significantly reduce porosity in concrete, renders and plasters through chemical combination with excess Ca(OH)₂ in a reaction that permanently binds the silicates with the surface of the material making it more abrasion resistant and water repellent. Soluble silicates are widely used in the production of paper and board products as an adhesive producing rigid high strength paper tubes and drums. It is this adhesive quality that led to sodium silicate being trialled in unfired clay mortars.

4. Experimental programme

The testing of sodium silicate mortars took place in two phases. The first phase involved the establishment of the optimal formulation, and the second phase more extensive testing on masonry manufactured with the chosen formulation.

4.1 Phase 1

Sodium silicate mortars were manufactured from three parts building sand, one part crushed unfired clay (as used in brick manufacture), and varying proportions of sodium silicate solution (by volume). Although the brick 'clay' is technically not a clay, as it has only 25% clay-sized particles, throughout this document it is referred to by its common name in the industry. The ratio of sand to brick clay was chosen to minimise drying shrinkage of the mortar. Water was added to produce a flow table value of between 150 and 170 mm which indicates a similar workability to conventional mortars. The clay from the brick being tested was used for the crushed clay in the mortar. This was done in order to maximise the

Material	Embodied carbon: kg CO ₂ equivalent/kg
Sand	0.0051
Cement	0.74
Lime	0.78
Unfired clay	0.024
Sodium silicate	0.06

Table 2. Embodied carbon for constituent parts of mortars

compatibility between the mortar and the brick. Figure 2 shows the characteristics of the sand and clay used in the mortar.

In each case three triplets of bricks were produced using a 10 mm mortar joint in order to have six sets of bond wrench data for each case. The bond was then tested at 7 days following the bond wrench test methodology outlined in BS EN 1052-5:2005 (BSI, 2005a) (Figure 3).

The results of these bond wrench tests are presented in Table 3. In conventional masonry it is generally accepted as preferable for failure in tension (flexure) and shear to occur within the weaker mortar joints rather than the stronger masonry units. However, in achieving adequate flexural bond strength here, it became evident during the experiments that brick strength was often to become a controlling parameter in unfired clay masonry performance. In some cases for the Ecobrick, it was

not possible to produce a failure either in the bond or in the brick within the loading limits of the apparatus. In other cases for the Ecoterre, the loading produced a diagonal failure in the brick, where both the bond strength and the shear strength of the mortar exceeded that of the brick. It was found that an evident relationship existed between early bond strength and concentration of sodium silicate, with a lower concentration of sodium silicate being required with the Ecobrick for the bond strength and mortar strength to exceed that of the brick.

Figure 4 shows the relationship between sodium silicate concentration and bond strength for the Ecoterre brick, and this is related to the tensile strength of the brick. It was found with the Errol brick that concentrations of silicate greater than 45 : 15 : 8 (sand : clay : sodium silicate) consistently produced bonds with a bond strength greater than the tensile strength of the bricks. For the Ecoterre brick concentrations of sodium silicate of 45 : 15 : 12 (sand : clay : sodium silicate) were required to produce consistent failure in the brick. As a result of this, optimum formulations for the mortar were settled on as 45 : 15 : 8 (sand : clay : sodium silicate) for the Errol Brick and 45 : 15 : 12 (sand : clay : sodium silicate) for the Ecoterre brick. Tests at 3 days were then conducted using the optimum formulations, to establish early bond strength, which has implications on ‘buildability’. The higher the early bond strength, the less sensitive the joints are to disturbance such as knocks that can occur during the construction process.

At an early stage in the research programme the manufacturers of the Ecobrick went out of business, and the focus of the

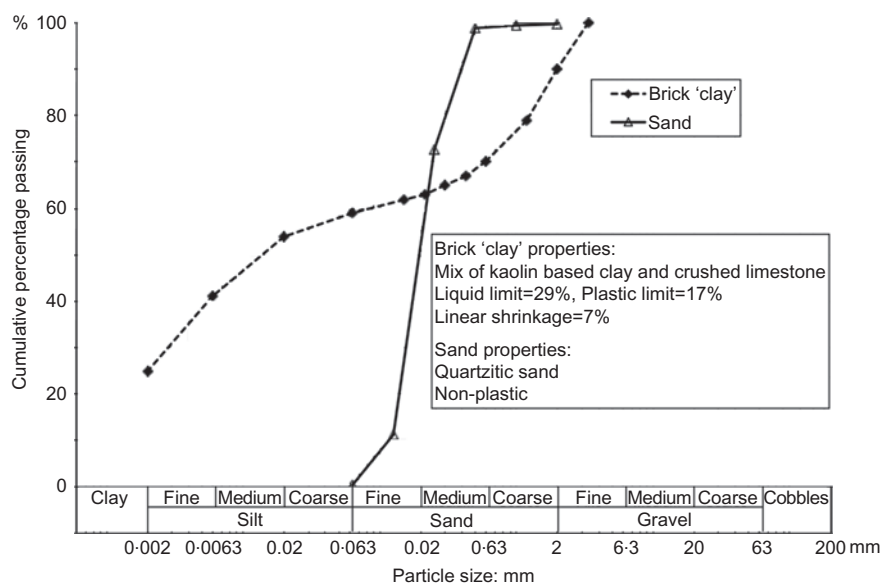

Figure 2. Characteristics of sand and clay used in the sodium silicate mortar

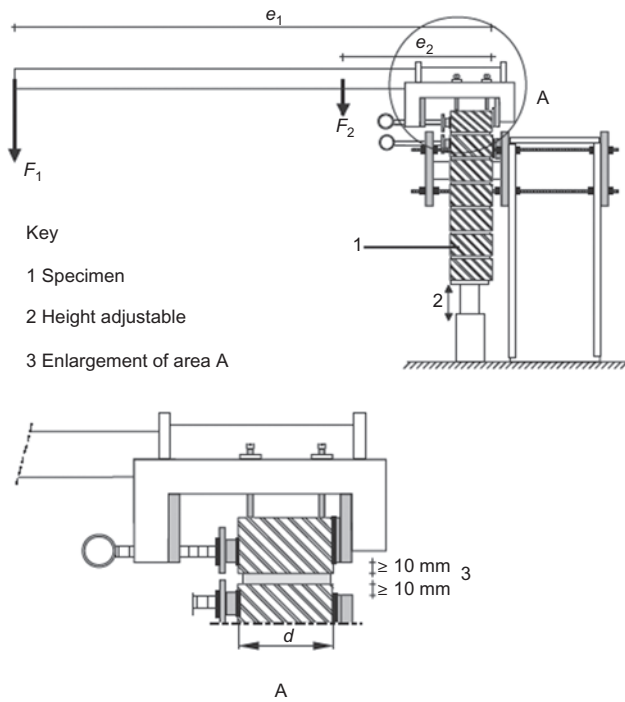

Figure 3. Bond wrench mechanism per BS EN 1052-5:2005 (BSI, 2005a)

research concentrated on the only remaining generally available unfired clay brick, the Ecoterre.

As can be seen from Table 3, at 3 days a formulation using 12 parts sodium silicate to 60 parts sand and clay produced a mean bond strength for the Ecoterre brick in excess of that required to maintain stability in a 100 mm thick wall.

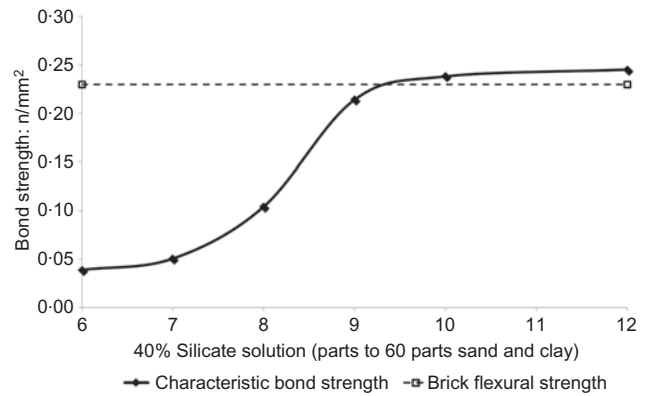

Figure 4. Relationship between bond strength and sodium silicate quantity for Ecoterre bricks

Based on these data, it was decided to move to phase 2 using a formulation based on 12 parts of 40% sodium silicate solution to 45 parts sand and 15 parts crushed clay. This mix required no additional water to be added to produce an acceptable flow for the purposes of brick-laying. The concentration was such that a bond greater than the shear strength of the brick could be established at an early stage in construction, thereby allowing brick-laying to proceed at an economic pace.

4.2 Phase 2

For the second phase of testing, 21 triplets of Ecoterre bricks were made in order to test the bond strength at 7, 14, 28, 63, 91, 182 and 364 days according to BS EN 1052-5:2005 (BSI, 2005a). In addition masonry wall panels were constructed to test for compressive strength according to BS EN 1052-1:1999 (BSI, 1999a), flexural strength according to BS EN 1052-2:1999 (BSI,

Brick	Mix details Sand : clay : sodium silicate (by volume)	Age at test: days	Bond strength: N/mm ²			Failure mode
			Mean	Characteristic	Coefficient of variation: %	
Ecobrick	45 : 15 : 6	7	0.05	0.03	4.8	Bond
Ecobrick	45 : 15 : 7	7	0.07	0.03	3.2	Bond
Ecobrick	45 : 15 : 8	7	0.16	0.06	4.8	Bond
Ecoterre	45 : 15 : 6	7	0.05	0.04	10.8	Bond
Ecoterre	45 : 15 : 7	7	0.09	0.10	19.5	Bond
Ecoterre	45 : 15 : 8	7	0.19	0.10	20.3	Bond/mortar
Ecoterre	45 : 15 : 9	7	0.23	0.21	3.3	Mortar
Ecoterre	45 : 15 : 10	7	0.26	0.24	3.3	Brick/mortar
Ecoterre	45 : 15 : 12	7	0.32	0.24	4.6	Brick
Ecobrick	45 : 15 : 8	3	0.12	0.03	12.1	Mortar
Ecoterre	45 : 15 : 12	3	0.22	0.14	18.4	Brick/mortar

Table 3. Bond wrench test results for trial mortar formulations

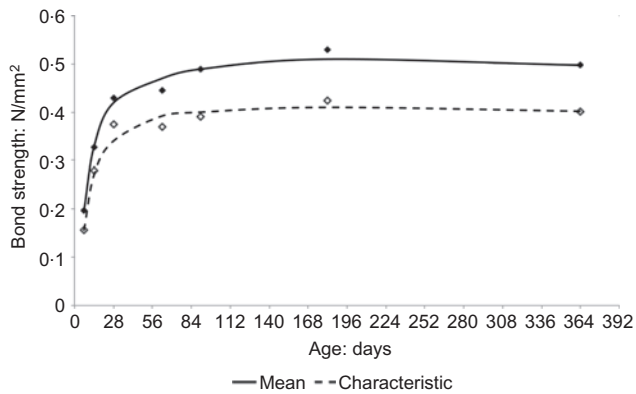

Figure 5. Bond strength data for a 12 part 40% sodium silicate solution to 60 parts sand/clay mortar with Ecoterre bricks

1999b) and initial shear strength according to BS EN 1052-3:2002 (BSI, 2002). A wall was also constructed, four bricks wide and 13 bricks high, to measure shrinkage as the mortar dried out. In all cases the mortar bed was 10 mm. All specimens were stored in a climate-controlled chamber at 20°C and 60% relative humidity (RH) in order to ensure comparability between results. This is important since the compressive strength of unfired clay bricks is sensitive to moisture content (Heath *et al.*, 2009). The wall testing was conducted 56 days after manufacture.

4.3 Bond strength

The results of the bond strength data up to 364 days are presented in Figure 5.

In all cases from 28 days onwards, the failure during flexural testing was in the brick. These data show that the bond strength exceeds the required strength within 7 days of manufacture, and that by 28 days it exceeds the strength of

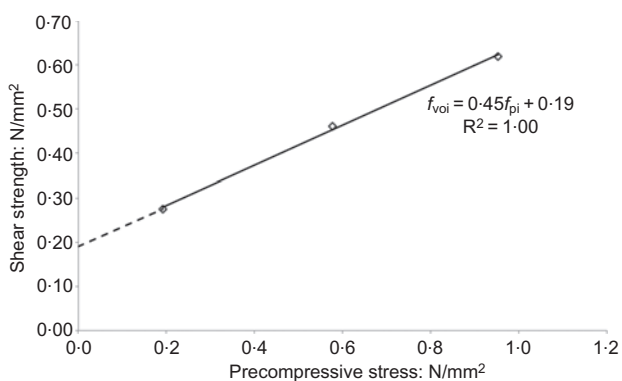

Figure 6. Mean shear strength of a 12 part 40% sodium silicate solution to 60 parts sand/clay mortar with Ecoterre bricks

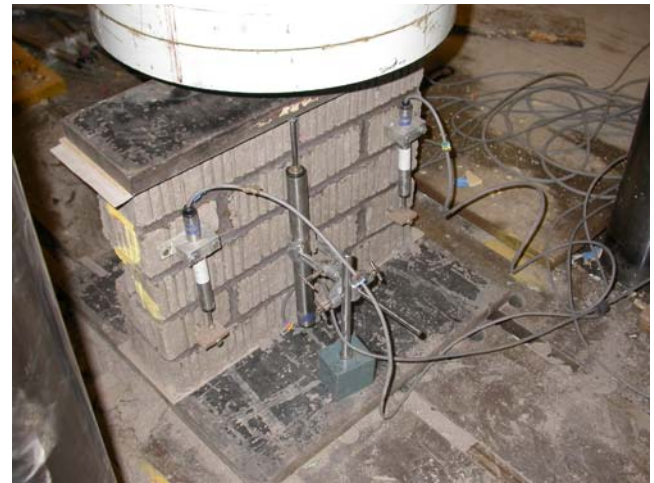

Figure 7. Set-up for compressive tests according to BS EN 1052-1:1999 (BSI, 1999a)

the brick. The minor decrease in strength seen at 365 days is within experimental error and not considered to be significant, particularly as the characteristic strength remained well above the target of 0.2 N/mm².

4.4 Initial shear strength

The data from the initial shear strength test are presented in Figure 6.

The mode of failure was generally shear failure in the unit (defined as A3 in BS EN 1052-3:2002 (BSI, 2002)), at higher pre-compressions some failures were crushing or splitting failure in the units (type A4). In no case did the bond fail. Mean initial shear strength determined by the linear regression was 0.193 N/mm².

Specimen no.	Density: kg/m ³	Compressive strength of the wall: N/mm ²
1	2020	2.42
2	2050	2.52
3	2020	2.47
4	2030	2.49
5	2030	2.62
6	2040	2.40
Mean	2030	2.49
Std deviation	10	0.08

Table 4. Results of compression tests



Figure 8. Set-up for flexural tests (perpendicular to bed joint) according to BS EN 1052-2:1999 (BSI, 1999b)

4.5 Compressive strength

Figure 7 shows the test set-up for compressive strength testing. Displacement transducers were positioned on both sides of the wall to measure deformations. Two sheets of Teflon were placed between the platen and the specimen in order to minimise friction during the test. Loading was applied at $0.15 \text{ N/mm}^2 \text{ min}$ which produced a failure in around 24 min (the standard calls for a failure time of between 15 and 30 min). Typically the mode of failure was a vertical split through the narrow face of the wallette. The test results are shown in Table 4.

The characteristic compressive strength of the masonry walls is 2.07 N/mm^2 . This is similar to the characteristic compressive strength of the bricks. The compressive strength of the sodium silicate mortar was measured at 9.48 N/mm^2 . The mode of failure indicates that the bricks were the weakest element of the

composite since the failure does not follow either the line of the bond or of the mortar.

4.6 Flexural strength

Figure 8 shows the set-up for the vertical flexural test and Table 5 presents the results of the flexural tests. As with the compressive tests, failure occurs in the bricks rather than in the mortar or at the brick/mortar interface. This was the case in both orientations, failure occurring in the bricks rather than in the mortar or at the mortar/brick interface, which is more typical for fired clay brick and concrete block masonry. Once again the limiting strength is the brick.

4.7 Drying shrinkage

To measure drying shrinkage the specimen walls had targets affixed to them across eight joints vertically and three joints horizontally. The walls were 13 courses high, four bricks wide, and unrestrained. Walls were kept in a climate-controlled chamber at 20°C and 60% RH and allowed to dry naturally. Surface strains were measured periodically using a DEMEC gauge, taking measurements in pairs of four joints vertically and one/two horizontally on both sides of each wall (Figure 9). The resultant data were averaged over three walls and are shown in Figure 10. The rate of shrinkage for each wall was similar, but the absolute amount of shrinkage for each wall varied. The ultimate vertical shrinkage over eight joints was 0.91 mm (wall 1), 0.81 mm (wall 2) and 0.77 mm (wall 3).

In the first few days after construction there was an initial high shrinkage (0.2% after 4 days) which gradually slows down over a period of about 6 weeks. Total shrinkage is around 0.4% horizontally, and slightly less vertically. By 56 days, when the masonry tests were conducted, drying shrinkage appeared to have finished. A 0.4% shrinkage would result in a shrinkage gap of just under 10 mm in a 2.4 m high unfired clay brick masonry wall. This is two orders of magnitude larger shrinkage

	Flexural tests (perpendicular to bed joint)		Flexural tests (parallel to bed joint)	
	Flexural strength f_{xi} : N/mm^2	Density of wall: kg/m^3	Flexural strength f_{xi} : N/mm^2	Density of wall: kg/m^3
Panel 1	0.59	2035	0.39	2047
Panel 2	0.54	2052	0.44	2060
Panel 3	0.49	2029	0.41	2025
Panel 4	0.56	2040	0.44	2061
Panel 5	0.67	2049	–	–
Panel 6	0.56	2033	–	–
Mean	0.57	2039	0.42	2048
Std deviation	0.06	9	0.03	17

Table 5. Results of flexural tests

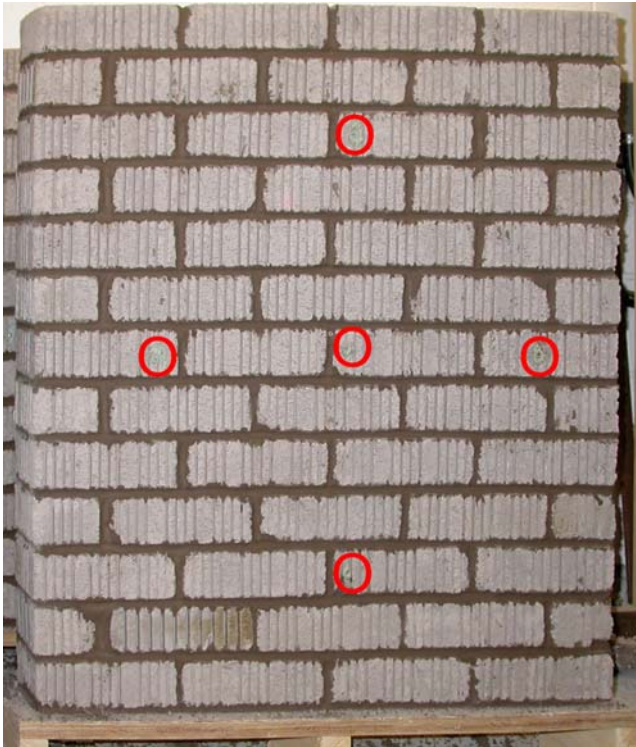

Figure 9. Shrinkage wall:p of DEMEC targets circled

than would be expected from a fired brick wall (Brooks and Abu Bakar (2004) measured shrinkages of between 0.0015 and 0.002%), and due allowance would need to be made in the construction planning in order to accommodate this.

5. Conclusion

The tests conducted on unfired clay brick masonry walls bonded with sodium silicate mortar clearly show that the

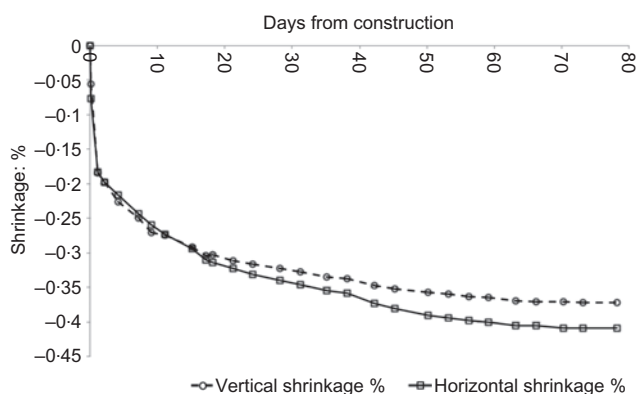

Figure 10. Shrinkage data for Ecoterre sample walls held at 60% RH and 20°C from date of manufacture

mortar is fit for purpose for the combination of bricks tested. It performed better than other mortars and had a lower embodied energy and carbon than conventional cement mortars. The high levels of shrinkage, associated with moisture necessarily used to make the mortar, has the potential to create particular problems which need to be allowed for in construction planning. However, as most shrinkage occurs during the first 24 h, some allowance for shrinkage can be made during the construction phase.

This research has demonstrated that it is possible to construct thin masonry walls from unfired clay bricks which have adequate structural performance. The benefits that accrue from this are listed here.

- Unfired clay bricks offer the potential for passive regulation of relative humidity, thereby improving the internal environmental conditions.
- The manufacture of 'standard-sized' unfired clay bricks using fired clay brick production lines offers efficiency and cost savings.
- The use of thin wall construction increases the available space within a building, reducing the construction cost per square metre in comparison with traditional forms of earthen construction such as adobe, cob or rammed earth construction.
- The use of unfired clay masonry walls in place of concrete block or brick walls contributes towards reductions in the carbon footprint of construction.
- The use of sodium silicate mortars instead of cement-based mortars further reduces the carbon footprint of construction.

Although unfired clay bricks are used for external walls in Germany, it is likely that the main application in the UK will be for internal non-load-bearing walls, where advantage can be taken of the low carbon cost of this method of construction, its thermal mass, its ability to regulate relative humidity and its sound insulation qualities. Care needs to be taken to minimise the risk of inundation and of exposure to rainfall through appropriate detailing.

REFERENCES

- Brooks JJ and Abu Bakar BH (2004) Shrinkage and creep of masonry mortar. *Materials and Structures* **37**(3): 177–183.
- BIS (Department for Business Innovation and Skills) (2011) Low carbon construction action plan. See <http://www.bis.gov.uk/policies/business-sectors/construction/low-carbon-construction-igt/low-carbon-construction-action-plan> (accessed 08/11/2011).
- BSI (British Standards Institution) (1999a) BS EN 1052-1:1999. Methods of test for masonry – Part 1: Determination of compressive strength. BSI, London, UK.

- BSI (1999b) BS EN 1052-2:1999. Methods of test for masonry – Part 2: Determination of flexural strength. BSI, London, UK.
- BSI (2002) BS EN 1052-3:2002. Methods of test for masonry – Part 3: Determination of initial shear strength. BSI, London, UK.
- BSI (2005a) BS EN 1052-5:2005. Methods of test for masonry – Part 5: Determination of bond strength by the bond wrench method. BSI, London, UK.
- BSI (2005b) BS EN 1996-1-1:2005 Eurocode 6. Design of masonry structures. General rules for reinforced and unreinforced masonry structures. BSI, London, UK.
- DCLG (Department for Communities and Local Government) (2006) *Code for Sustainable Homes*. DCLG, London, UK.
- DCLG (2007) *Building a Greener Future: Policy Statement*. DCLG, London, UK.
- DECC (Department of Energy and Climate Change) (2011) *Statistical Release: UK Climate Change Sustainable Development Indicator: 2010 Greenhouse Gas Emissions, Provisional Figures and 2009 Greenhouse Gas Emissions, Final Figures by Fuel Type and End-User, 31st March 2011*. DECC, London, UK.
- Fawer M, Concannon M and Rieber W (1999) Life cycle inventories for the production of sodium silicates. *International Journal of Life Cycle Assessment* **4**(4): 207–212.
- Heath A, Walker P, Fourie C and Lawrence M (2009) Compressive strength of extruded unfired clay masonry units. *Proceedings of the Institution of Civil Engineers: Construction Materials* **162**(3): 105–112.
- IEA (International Energy Agency) (2007) *Tracking Industrial Energy Efficiency and CO₂ Emissions*. IEA, Paris, France.
- Hammond GP and Jones CP (2008) Embodied energy and carbon in construction materials. *Proceedings of the Institution of Civil Engineers: Energy* **161**(2): 87–98.
- Innovation and Growth Team (2010) *Low Carbon Construction – Final Report*. Department for Business Innovation and Skills, London, UK.
- Lawrence M, Heath A and Walker P (2008) Modern innovations with unfired clay masonry. In: *Proceedings of 8th International Seminar on Structural Masonry (ISSM 08)*, Istanbul, Turkey, 5–8 November 2008.
- Minke G (2006) *Building with Earth: Design and Technology of a Sustainable Architecture*. Birkhäuser, Basel, Switzerland.
- Morton T (2006) Feat of clay. *Materials World* **14**(1): 2–3.
- Morton T (2008) *Earth Masonry: Design and Construction Guidelines*. BRE Press, Bracknell, UK.
- Otaka T and Asako Y (2002) Thermal intumescent characteristics of heated sodium silicate. *ASME 2002 International Mechanical Engineering Congress, New Orleans, LA, USA*, 17–22 November 2002.
- Padfield T (1998) *The Role of Absorbent Building Materials in Moderating Changes of Relative Humidity*. PhD thesis, The Technical University of Denmark, Kongens Lyngby, Denmark.
- United Nations (1998) *Kyoto Protocol to the United Nations Framework Convention on Climate Change*. UNFCCC Secretariat, Bonn, Germany.
- Walker P, Heath A and Lawrence RMH (2008) Modern innovations in unfired clay masonry in the UK. In: *Proceedings of the 10th International Conference on the Study and Conservation of Earthen Architectural Heritage, Bamako, Mali*, 1–5 February 2008.

WHAT DO YOU THINK?

To discuss this paper, please email up to 500 words to the editor at journals@ice.org.uk. Your contribution will be forwarded to the author(s) for a reply and, if considered appropriate by the editorial panel, will be published as discussion in a future issue of the journal.

Proceedings journals rely entirely on contributions sent in by civil engineering professionals, academics and students. Papers should be 2000–5000 words long (briefing papers should be 1000–2000 words long), with adequate illustrations and references. You can submit your paper online via www.icevirtuallibrary.com/content/journals, where you will also find detailed author guidelines.