



*Citation for published version:*

Ross-Pinnock, D & Mullineux, G 2018, 'Thermal compensation using the hybrid metrology approach compared to traditional scaling: DET 2016 Special Edition ', *Proceedings of the Institution of Mechanical Engineers, Part B: Journal of Engineering Manufacture*, vol. 232, no. 13, pp. 2364-2374.  
<https://doi.org/10.1177/0954405417733766>

*DOI:*

[10.1177/0954405417733766](https://doi.org/10.1177/0954405417733766)

*Publication date:*

2018

*Document Version*

Peer reviewed version

[Link to publication](#)

Ross-Pinnock, D. Mullieux, G., Article Title, Thermal compensation using the hybrid metrology approach compared to traditional scaling, *Proceedings of the Institution of Mechanical Engineers, Part B: Journal of Engineering Manufacture*. Copyright © 2017 IMechE. Reprinted by permission of SAGE Publications.

**University of Bath**

**Alternative formats**

If you require this document in an alternative format, please contact:  
[openaccess@bath.ac.uk](mailto:openaccess@bath.ac.uk)

**General rights**

Copyright and moral rights for the publications made accessible in the public portal are retained by the authors and/or other copyright owners and it is a condition of accessing publications that users recognise and abide by the legal requirements associated with these rights.

**Take down policy**

If you believe that this document breaches copyright please contact us providing details, and we will remove access to the work immediately and investigate your claim.

# Thermal compensation using the Hybrid Metrology approach compared to traditional scaling

**D Ross-Pinnock\*, G Mullineux**

Department of Mechanical Engineering, University of Bath, Bath, BA2 7AY, United Kingdom

\* Corresponding author. Tel.: +44 1225 386052; E-mail address: [d.r.ross-pinnock@bath.ac.uk](mailto:d.r.ross-pinnock@bath.ac.uk)

## Abstract

Manufacturers are currently facing large volume metrology challenges driven by thermal effects such as variation in refractive index and thermal expansion. Thermal expansion is one of the largest contributors to measurement uncertainty and it can often be difficult to realise the standard 20°C temperature required. The current process for dimensional measurement requires that the temperature is measured at the instrument, and the entire measurement volume is scaled linearly by a single scale factor. For more complex temperature distributions as found in industry where temperatures vary by several degrees at a given time, this scaling is inadequate. This is particularly problematic where product specifications are demanding. Temperature measurement capability and dimensional measurement scaling have been identified as major issues in thermal compensation methodologies.

Photogrammetry has been used to measure deformations in two challenging metrology scenarios with convective localised heating. Extended use of temperature measurement has been exercised in concert with finite element analysis to create a compensation methodology for large volume coordinate measurement. The Hybrid Metrology method has been compared to commonly used uniform scaling techniques and has outperformed these with a highly simplified FEA simulation. The methodology is capable of easily scaling a large number of coordinates at once. This work has highlighted the need for future focus on a reproducible temperature measurement planning approach for large volume measurement in non-standard environments - this was found to be the most significant contributor to compensation error.

**Keywords:** Large volume metrology; thermal compensation; photogrammetry; finite element analysis (FEA); Light Controlled Factory (LCF)

## Introduction

The manufacture of products, particularly at the large scale, requires accurate measurement techniques. Specifications for product assembly in space and aerospace applications can be demanding and can be affected by deformation<sup>1</sup>. There has been great interest in measurement assisted assembly techniques (MAA) that can improve these processes<sup>2,3</sup>. Here, the key limitation is in the dimensional uncertainty that can be achieved.

Thermal effects are a large – often the largest – source of uncertainty in dimensional measurement<sup>4-6</sup>. Standard metrology temperature is 20°C<sup>7</sup>, and ideally the metrology environment is temperature-controlled to achieve this. Large scale applications rarely have this luxury as it can often be impractical, and prohibitively costly to achieve in such vast volumes. Thermal gradients can be observed of several degrees vertically and horizontally. Temporally, variations of 10-15°C in 24 hours could be expected in a large volume assembly, integration and test (AIT) environment. This can significantly affect assembly variation<sup>8,9</sup>.

Many instruments for large volume metrology are also afflicted by uncertainties due to ambient refractive index changes. Temperature is one of the main contributors to refractive index variation<sup>10</sup>, alongside other variables such as pressure, humidity, air composition (e.g. CO2 levels), and particulate contaminants (e.g. dust).

When measurements are made at non-standard temperatures, scaling back to 20°C has to be performed based upon the coefficient of thermal expansion (CTE) of the material to be measured. Common materials such as aluminium alloys have significant thermal expansion:  $23.4 \mu\text{m}\cdot\text{m}^{-1}\cdot^{\circ}\text{C}^{-1}$ .

Two major problems in thermal compensation methodologies are the temperature measurement planning, and the method of scaling. Hybrid Metrology was created for dimensional measurement scaling in complex, non-standard thermal environments. Temperature measurement data combined with computational simulation of thermal expansion can be used to model deformation, and subsequently transform measured 3D coordinates<sup>11</sup>.

Although one of the most widely measured quantities<sup>12</sup>, temperature measurement is not comprehensively carried out in assembly environments. Laser trackers are portable coordinate measurement machines (PCMMs), which have a weather station measuring temperature at the instrument, alongside pressure and humidity. This may be different to that which is to be measured (e.g. product or tooling structure). Temperature measurement technologies suitable for thermal compensation in AIT environments have been identified<sup>13</sup> and literature reviewed in detail<sup>14</sup>. In many areas of engineering manufacture there is a need to be able to understand and model thermal effects. This is particularly true for machine tools where thermal effects can affect the accuracy of manufacture<sup>15-17</sup>.

Photogrammetry is an increasingly common measurement technique in large volume metrology. Targets are adhered to the surface of the measurand, many photographs are taken,

and software can measure these targets as coordinates when referenced to scale bars. The ability to measure multiple targets makes photogrammetry ideal for the measurement of deformation<sup>18</sup>. Photogrammetry does not typically have a weather station like the laser tracker. The number of measured points are numerous, making target-specific scaling attractive.

The Hybrid Metrology method has been outlined here and experimentally validated in challenging laboratory-scale photogrammetric measurements, before being compared to traditional thermal compensation methods. The main objective of this work was to highlight the most significant area to focus future research efforts in this field – temperature measurement or scaling. Temperature measurement planning is an area in which there is an opportunity to create a reproducible strategy so that dimensional metrologists can better communicate the context of their results regardless of the technologies they have available for scaling. The work also helped to validate the simulation and further develop the methodology so that it can be easily used for a large number of coordinates.

## Hybrid Metrology Thermal Compensation

The Hybrid Metrology approach has been created in a bid to integrate thermal and dimensional measurement. Hybrid Metrology refers to a methodology based upon the measurement of more than one physical quantity, combined with one or more computational processes including simulation for the scaling of dimensional measurements<sup>19</sup>.

For thermal compensation, Hybrid Metrology combines multi-positional temperature logging with finite element analysis (FEA) performed on the nominal CAD model to produce a scaling transformation of dimensional coordinates. The benefit of this method is that temperature is measured more broadly, and more complex thermal distributions can be compensated.

Fig. 1 provides some context as to how this methodology fits into manufacturing operations in order to provide thermal compensation to dimensional metrology. Product design specifications are provided to enable manufacturing, alongside a digital representation of the nominal product i.e. the CAD model. Components and sub-assemblies are manufactured to these specifications and used in the assembly, integration and test (AIT) of the product. Assembly operations are performed and dimensional inspection is carried out to ensure the assembly meets specifications. Measurements are taken on the physical product using the measurement instrumentation and the temperature sensors. In software, the coordinate measurements taken are aligned to match the coordinate system of the FEA and nearest nodes to measured targets are assigned. Temperature measurements are used to create boundary conditions to simulate within FEA the predicted thermal expansion based on the CAD data. The structural FEA produces displacement data which is used as part of a transformation on the measured coordinates to produce a simulated measurement that more realistically represents the conditions that the physical product is subjected to in the AIT environment. This data can be later used to make better decisions in assembly operations by providing more accurate measurements. One example would be to use the simulated measurement to

predict tolerance stack-up throughout the assembly. In other situations where there is reconfigurable tooling, this could be adjusted to improve assembly of the product.

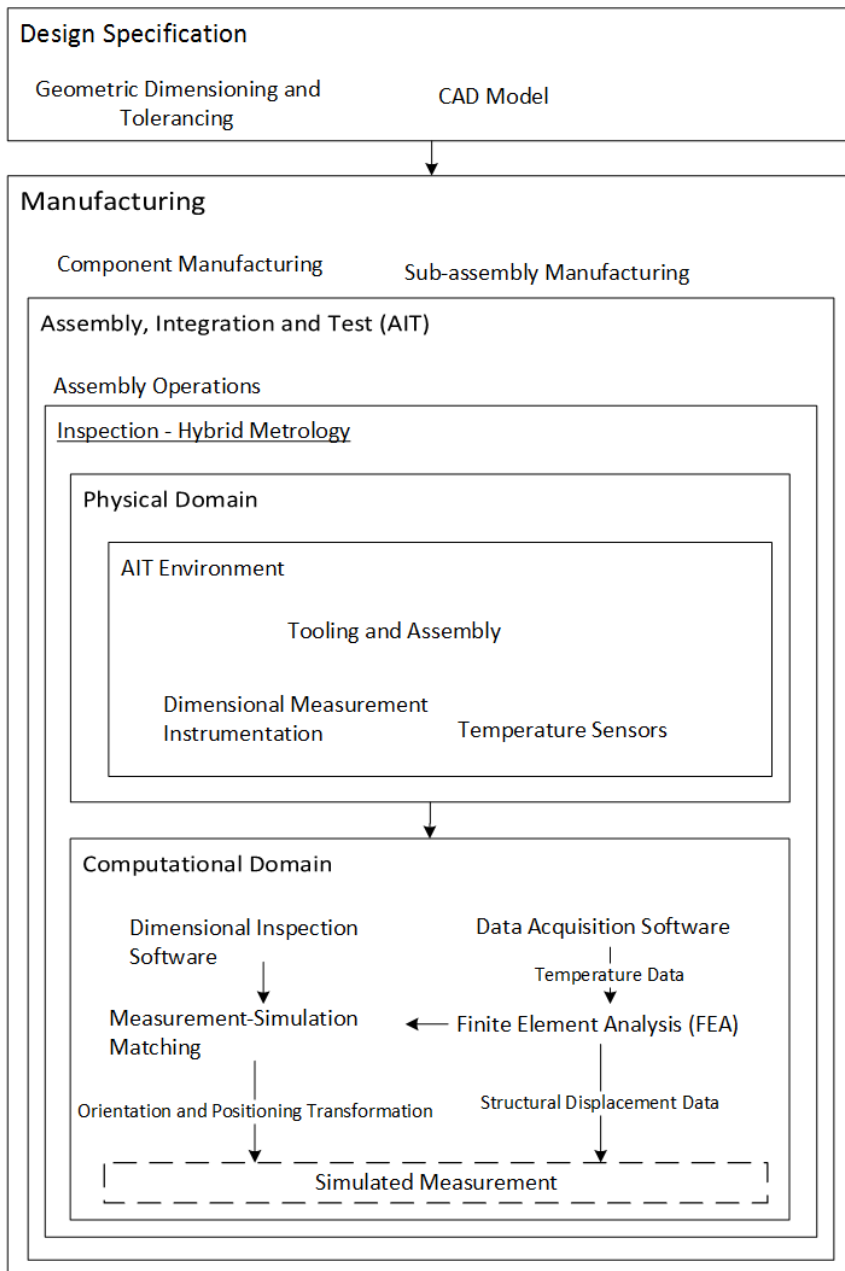

Fig. 1 - Diagram showing the context of the hybrid metrology approach in the context of manufacturing inspection

## Experimental Measurement Scenario

### Frame structure

The experimental measurand took the form of a cuboidal frame structure. Each of the 12 beam members were made from aluminium 6063 extruded profile by MiniTec, and were fastened with proprietary PowerLock fasters. The frame was 2 m in length, and 1 m height

and depth. These dimensions and material choice allowed for experiments to be carried out at the lab scale whilst providing maximum thermal expansion.

Supporting this frame were 4 ball transfer units, which sat at the four bottom corners of the frame. Each of the ball transfer units rested upon flat plates adhered to the floor, which allowed the frame to expand more smoothly. One ball transfer unit was nested in a hole drilled into one of the plates in order to provide a translational constraint. To reset the frame position repeatably, and to provide constraint for yaw rotation of the frame, a fiducial post was fixed to the floor for the frame to rest against.

## Heating method

At normal ambient temperature the laboratory environment was relatively stable, varying less than a degree at various positions on the frame. Heating of the structure was performed using a fan heater. Convective heating is the primary heat source in industrial environments and the fan heater allowed for exaggerated heating in order to significantly observe thermal expansion beyond the uncertainty of the measurement technique. The heater was placed outside of the frame next to the bottom corner, facing inwards.

## Metrology

### Dimensional metrology – photogrammetry

An Aicon DPA photogrammetry system<sup>20</sup> was used for these measurements. a modified Nikon 3dx digital single lens reflex (DSLR) camera equipped with a 28 mm Nikkor prime lens. Image transfer was achieved quickly using a local WiFi connection to a laptop computer. Proprietary software called Aicon 3D Studio is used for these measurements and some analysis of measurement data. 14-bit ANCO coded targets were fixed to the surface of the structure.

200 to 250 images were captured at a range of elevations and orientations around the structure per measurement. Roughly 10 vantage points were used in standing and crouching positions, with 8 ladder positions allowing for improved vertical vantage points. In total, each measurement took 15-20 minutes to complete.

### Temperature Measurement

Type T thermocouples and class A platinum resistance temperature detectors (RTDs) were used throughout the experiments to measure surface temperature on the frame. Thermal

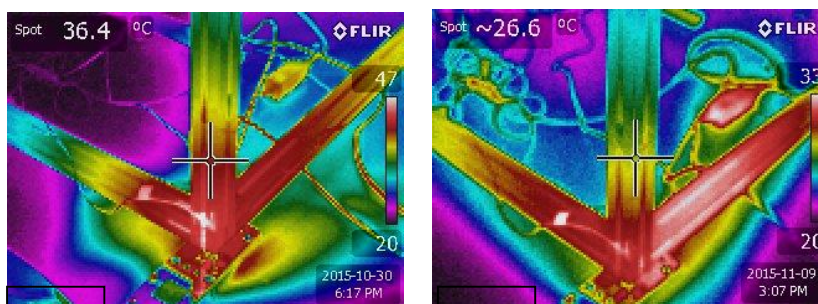

Fig 2 - Example thermal images of a) H2F1 and b) H1P2

imaging was also carried out to characterise the temperature distribution of the frame when heated by the fan heater.

Thermal images for H2P1 and H1P2 can be seen in Fig. 2 showing the magnitude, and highly localized nature of the heating.

An FLIR handheld infrared (IR) thermal imaging camera with an absolute accuracy claimed by the manufacturer to be  $\pm 2^{\circ}\text{C}$ <sup>21</sup> was used. The sensitivity of the camera is stated as  $<0.045^{\circ}\text{C}$  meaning that the camera is particularly useful in a qualitative capacity for sensor positioning.

Using the thermal images, invasive sensor positions were assigned and can be seen in Fig. 3. Sensor density around the heated corner was increased to capture some of the complexity of the localized temperature distribution. Ambient temperature was recorded using a thermocouple (TC0). RTD sensors are more accurate than thermocouples and therefore were used around the heated corner to increase the density in this area. A further twelve thermocouples covered the frame.

## Computational thermal compensation

### Geometry

Simplified CAD geometry was created for the frame to allow for the simulation to run quickly. Chamfers, fillets and other small details were removed from the geometry. Performing this simplification in the geometry more than halved the simulation run time. Speed of simulation would be important for metrology processes in manufacturing. Fig. 3 shows a rendering of the frame and temperature sensor positions are labelled, where TC0-12 are thermocouples and RTD0-3 are thin film platinum resistance thermometers.

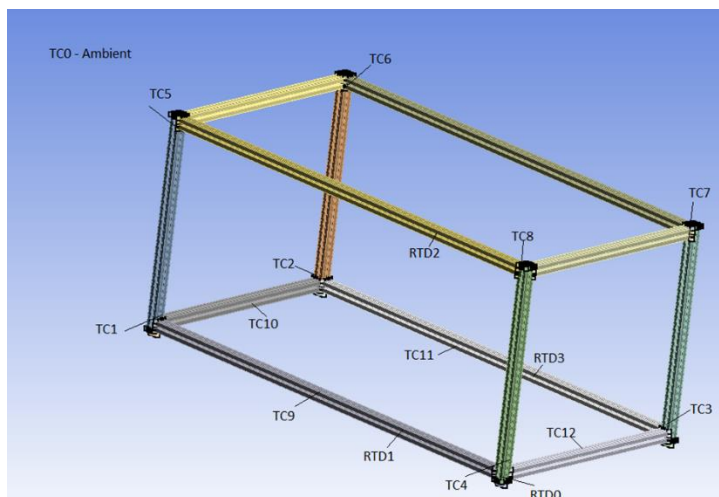

Fig. 3 - Schematic of sensor positions on frame, where TC1 is the fixed corner and RTD0 is the heated corner

### Simulation – finite element analysis (FEA)

FEA was used to simulate the thermal expansion under heating. A one-way coupled system was used here in which a thermal analysis is performed to find the full temperature

distribution. The results are then passed to the structural analysis, which produces displacement results for each node on the geometry. Relatively coarse meshing is used for both phases of the FEA simulation, again to improve the simulation processing time.

### FEA Thermal analysis

Over the maximum measurement period the temperature varied by less than 0.1°C. As the temperature variation over this period was relatively small, a steady state thermal analysis was carried out. Average temperature for the period of the dimensional measurement were applied from each sensor at the corresponding FEA coordinates. The initial temperature parameter was set to be the average ambient measurement. Thermal analysis used only a conduction model to calculate temperature at unspecified nodes.

### FEA Structural Analysis

Using the thermal analysis solution, a static structural analysis was performed. Movement of the frame was constrained to match the experiment. The frame is supported using a displacement constraint in the vertical direction, with the horizontal movement unconstrained for three of the points of contact. The ball transfer unit that was constrained in the experiment was similarly constrained in all directions. Displacement solutions along the X, Y and Z axes were calculated for each node in the simulation.

### Target-node matching

Closely matching the coordinate systems of the measurement and the simulation allowed the nearest nodes from the FE mesh to be matched to each photogrammetry target. Measured coordinates were used in a Euclidean nearest neighbour search of the mesh node location data. The corresponding displacement results for the nearest node were used for each photogrammetry target.

## Comparison of scaling methods

In addition to simulation, there is also extensive use of temperature measurement in this methodology. Temperature is usually only measured using instrument weather stations unless there is a specific need for enhanced capability, or if the environment is particularly challenging.

Traditional scaling takes a single scaling factor calculated by multiplying the difference from standard temperature by the CTE, and adding 1 as shown in equation 1.

$$\textit{Scaling Factor} = 1 + (dT \times CTE) \quad (1)$$

To separate the benefits of temperature measurement and simulation, the thermal expansion should be calculated for the following:

- 1) Traditional scaling - minimal temperature measurement
  - a) Mean ambient temperature at the instrument
  - b) Mean temperature between maximum and minimum
  - c) Worst case scenario using maximum temperature



- 2) Traditional scaling - full temperature measurement
  - a) Mean temperature of all sensors
  - b) Median temperature of all sensors
- 3) Hybrid Metrology - all sensor data used, and finite element analysis displacements used to predict expansion.

## Results and discussion

Measurement of the structure was performed using the photogrammetry system and deformation analysis was carried out using the Aicon 3D studio software. The reference measurement HOPx was compared to its heated counterpart HxPx. Both sets of measurement data were initially matched using a best fit of the measured targets to ensure they were both fully aligned. The software then performed a deformation analysis, which calculates the displacement of the targets in the X, Y and Z directions. Fig. 4 shows the regions of interest, with the points measured in each region as well as the heater positions.

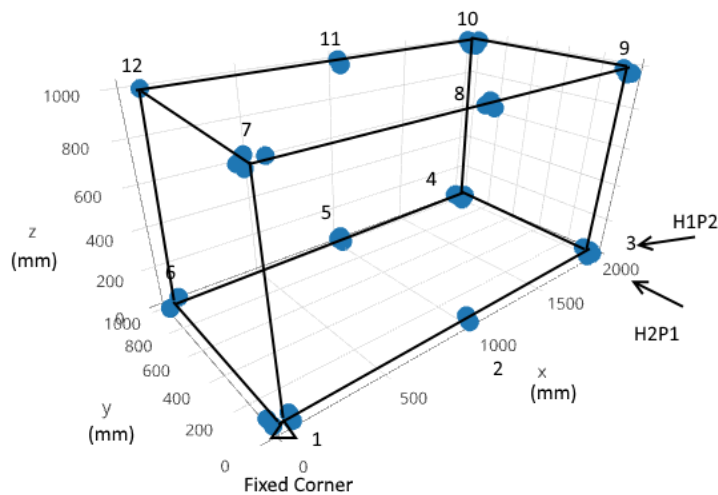

Fig. 4 - Illustration of the points measured at the numbered regions of interest with fixed point and heater positions

### Scenario 1 – H2P1

Temperatures in this scenario around the frame are shown in Table 1. Maximum temperature was more than 26 °C above standard temperature.

Sensor	Temperature (°C)
TC0	20.56
TC1	20.73
TC2	20.74
TC3	31.78
TC4	40.45
TC5	21.3
TC6	21.34
TC7	22.52
TC8	23.23

TC9	21.31
TC10	21.43
TC11	21.56
TC12	36.74
RTD0	46.78
RTD1	26.23
RTD2	22.47
RTD3	27.37

Table 1 - Temperatures measured around frame from thermocouples and RTDs

For the traditional scaling techniques, the temperatures used can be seen in Table 2.

Method ID	Method	Temperature (°C)	dT from standard (°C)	Scale Factor
1a	Ambient	20.56	0.56	1.000013
1b	Mean Max-Min	33.67	13.67	1.000320
1c	Max	46.78	26.78	1.000627
2a	Mean All	26.27	6.27	1.000147
2b	Median All	22.47	2.47	1.000058

Table 2 - Temperatures and scale factors used for each scaling method

For clarity, the results have been presented for the four 2m long beams (Fig. 5) and 1m inter-regional distances for the whole frame (Fig. 6). Using methods 1a, 1b and 1c results in low agreement to the measured results.

In Fig. 6, it can be seen that the ability of method 3 to scale for localised expansion is generally advantageous. Table 3 shows that the Hybrid method has a marginally lower mean difference to the measurement results over the various distances compared to other methods.

Method ID	Method	1m mean difference (mm)	2m mean difference (mm)
1a	Ambient	0.128	0.198
1b	Mean Max-Min	0.242	0.515
1c	Max	0.515	1.109
2a	Mean All	0.127	0.202
2b	Median All	0.122	0.198
3	Hybrid	0.082	0.179

Table 3 - Absolute mean differences from the heated measurement for each method for 1m and 2m distances in H2P1

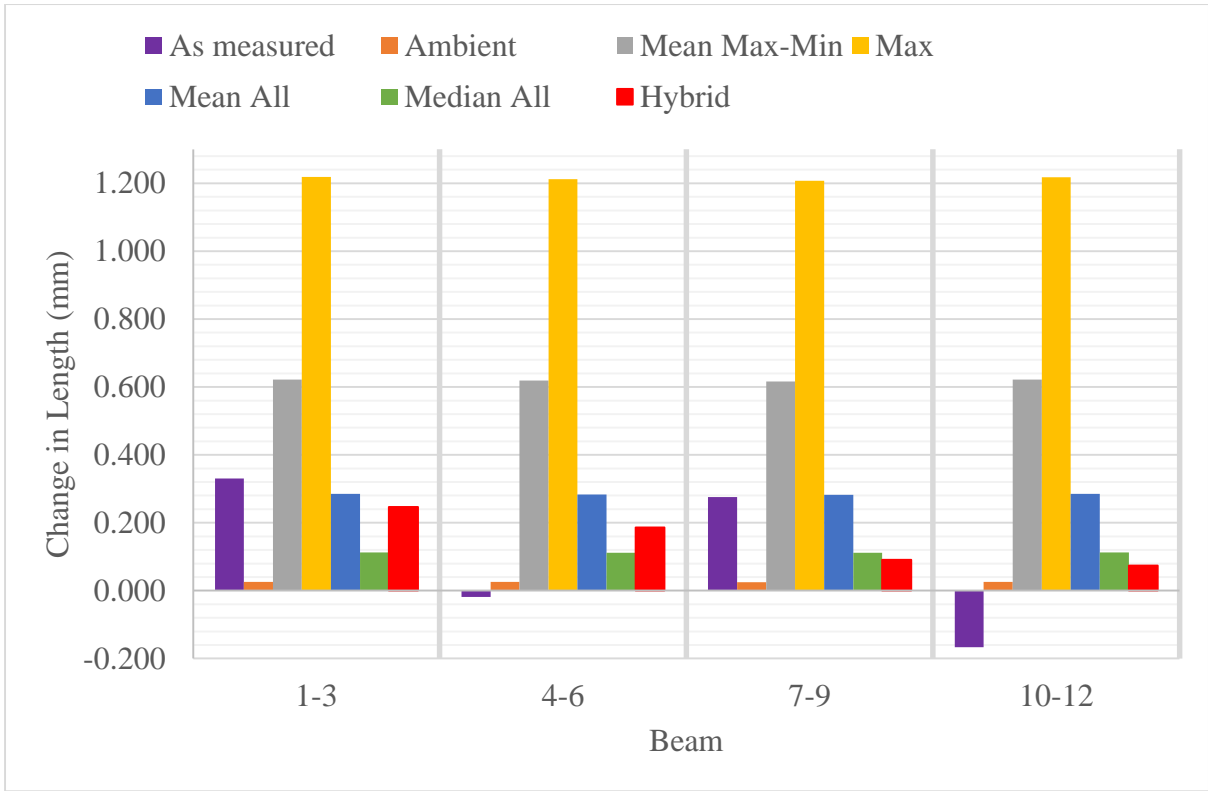

Fig. 5- Column chart showing thermal expansion in 2m beams for all methods compared to the measured value

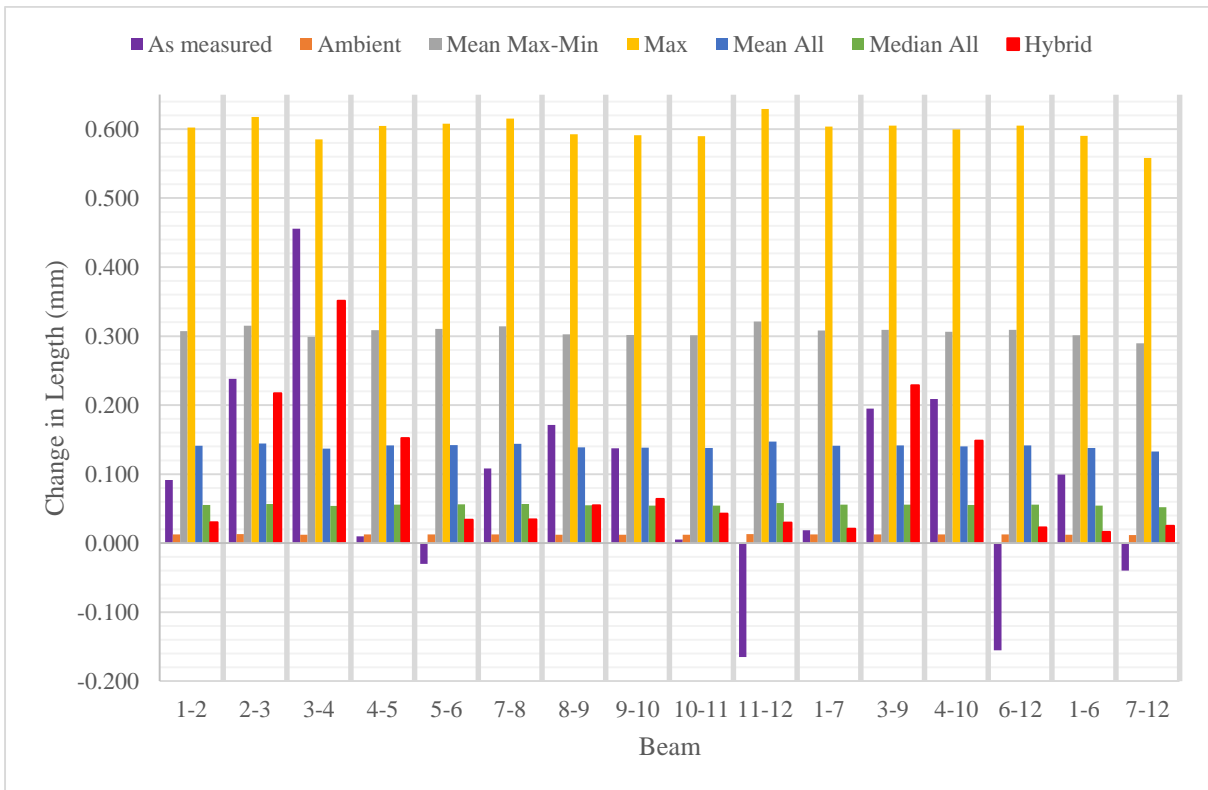

Fig. 6- Column chart showing thermal expansion in 2m beams for all methods compared to the measured value

## Scenario 2 – H1P2

Temperatures in this scenario around the frame are shown in Table 4 and are less extreme than the first scenario. Maximum temperature was in excess of 12 °C above standard temperature.

Sensor	Max Temperature (°C)
TC0	22.51
TC1	20.2
TC2	20.84
TC3	23.65
TC4	30
TC5	20.56
TC6	21.57
TC7	20.87
TC8	21.31
TC9	21.55
TC10	20.8
TC11	24.06
TC12	29.14
RTD0	32.34
RTD1	27.3
RTD2	21.53
RTD3	23.68

Table 4 - Temperatures measured in H1P2 from thermocouples and RTDs

Scaling factors for this scenario can be seen in Table 5. Once again there are a wide range of possible scaling factors due to the localised heating.

Method ID	Method	Temperature (°C)	dT from standard (°C)	Scaling Factor
1a	Ambient	22.51	2.51	1.000059
1b	Mean Max-Min	26.27	6.27	1.000147
1c	Max	32.34	12.34	1.000289
2a	Mean All	23.64	3.64	1.000085
2b	Median All	21.57	1.57	1.000037

Table 5 - Temperatures and scale factors used for each of the traditional scaling methods

In Fig. 7 and Fig. 8, we can again see that the Hybrid metrology method appears to agree a little more closely with the heated measurements.

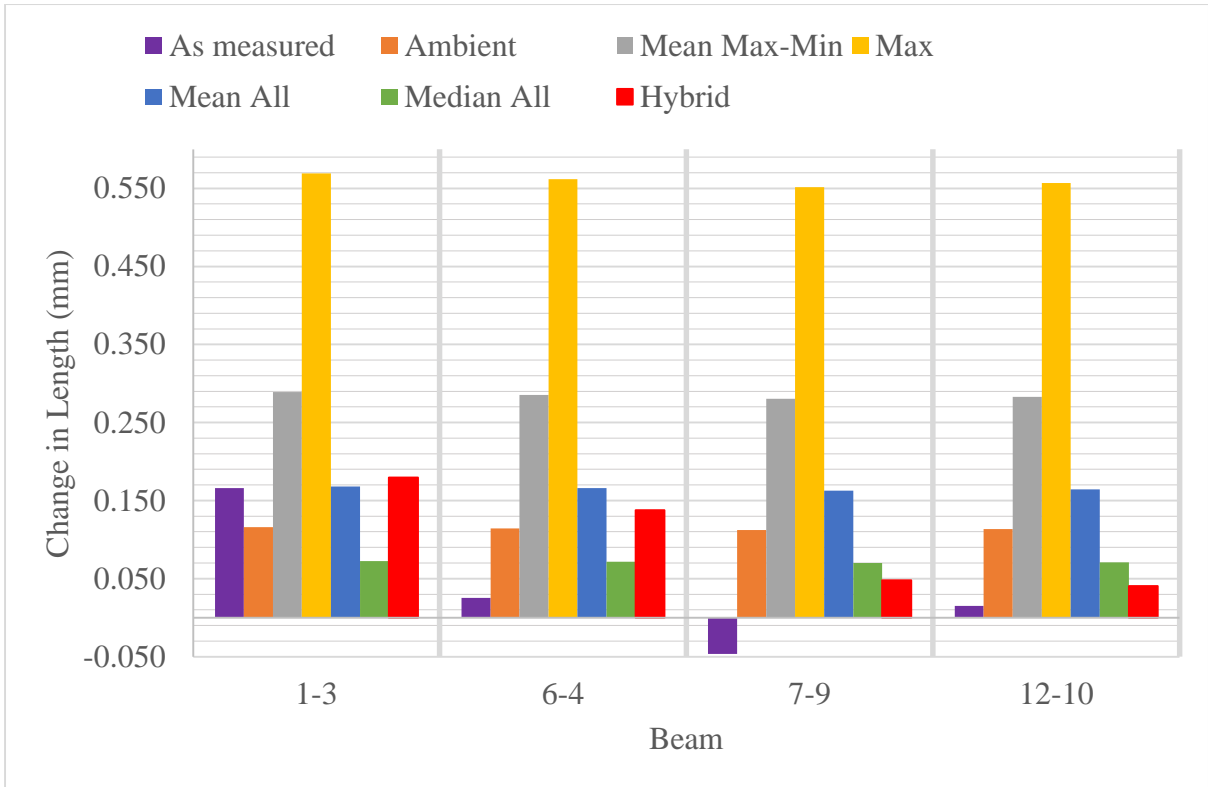

Fig. 7 - Column chart showing thermal expansion of all methods compared to measured value

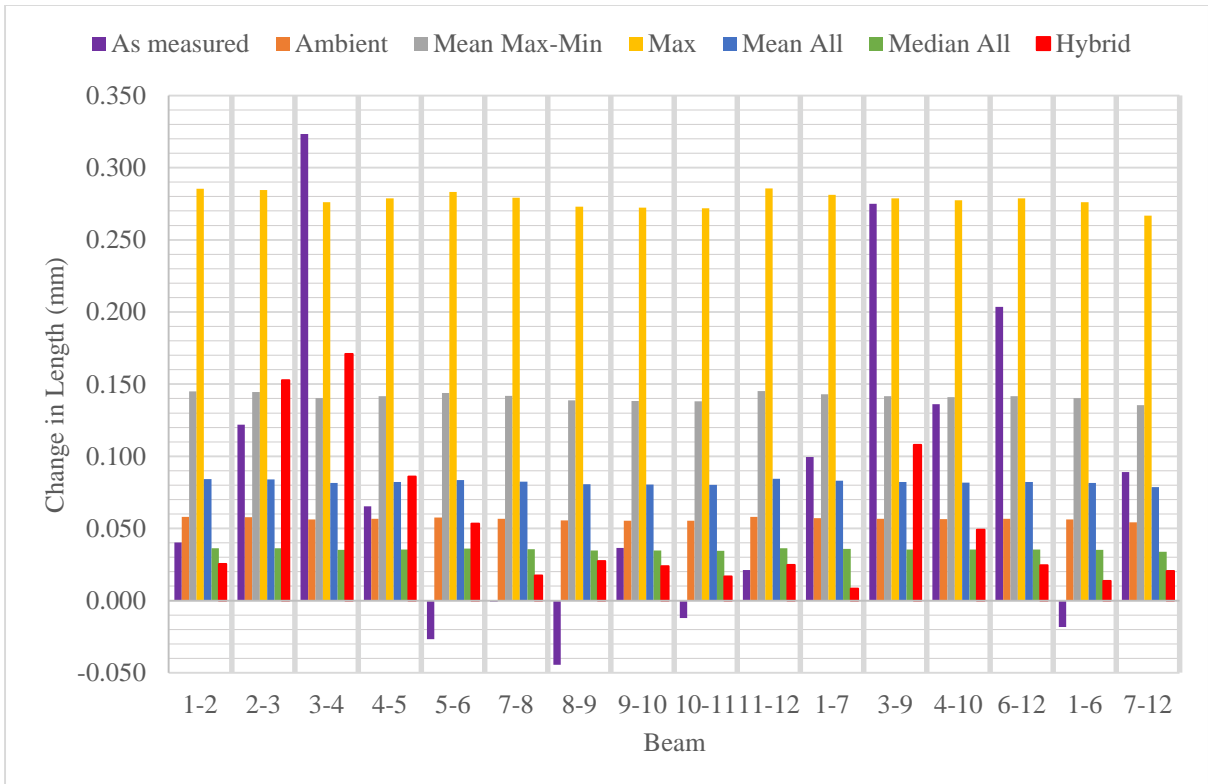

Fig. 8 - Column chart showing thermal expansion in 1m beams for all methods compared to the measured value

The mean magnitude of difference between the measured results for each of the scaling methods is given in Table 6. Ideal scaling would represent a mean difference tending towards zero, and in this case it can be seen that the Hybrid method generally outperforms than the traditional scaling methods with a mean value of 0.066 mm.

Method ID	Method	1m mean difference (mm)	2m mean difference (mm)
1a	Ambient	0.082	0.099
1b	Mean (Max-Min)	0.107	0.244
1c	Max	0.202	0.520
2a	Mean (All)	0.085	0.125
2b	Median (All)	0.083	0.078
3	Hybrid	0.066	0.061

Table 6 - Mean absolute difference in thermal expansion of all methods from the measured value

The Hybrid method can be said to have produced marginally better results than the uniform scaling methods. As the FEA carried out was highly simplified, these results although modest are promising. A number of factors can be improved from this initial study within the simulation to make a far more significant impact to the results. Fine meshing can be used alongside more complex geometry. A transient analysis can be used rather than steady state. The contacts between the beams can also be refined as these are modelled as being more stiff connections than is present in reality. Similarly, the stiffness of the beams themselves can be characterised. Once the finite element model is fully calibrated in this way, the results will become a function of the time spent in setting up the FEA. This is acceptable due to the modular nature of the Hybrid metrology approach, where experts in CAD, FEA and metrology can contribute separately in the initial setup. Ultimately, the major significant finding was the importance of temperature measurement as a far more pronounced difference can be seen from using a full complement of temperature measurement as opposed to one or two sensors.

## Conclusions

This paper has outlined and shown the application of a straightforward methodology for two things, the first being temperature measurement for dimensional metrology, which is currently often only carried out on the ambient temperature at the instrument. Finite element simulation of displacement allows for compensation of co-ordinates that would not be possible using current linear scaling methods, due to the presence of highly localized heating.

Two challenging measurement scenarios have experimentally showed that even a highly simplified FEA was able to modestly outperform the traditional scaling methods with both minimal and full temperature measurement.

Thermal compensation is only as effective as the measurement of temperature. Sparsely measured temperature is limited in value and important thermal effects can easily be missed. Temperature measurement is the major contributor to improvement in thermal compensation and can be further improved through the use of simulation.

## Future Work

Temperature measurement planning needs to be studied further specifically for use in large manufacturing environments so that users can easily optimise their temperature measurement for thermal compensation.

Further experimental studies and consultations with practitioners are to be carried out with a focus on optimising the temperature measurement strategy. Computational studies for temperature measurement planning are under way at the time of writing.

## Acknowledgements

The authors would like to gratefully acknowledge the financial support of the EPSRC, grant EP/K018124/1, “The Light Controlled Factory”. We also wish to thank the industrial collaborators for their contribution, as well as the Department of Mechanical Engineering at the University of Bath.

## References

1. Zhang L, Wang H, Li S and Lin Z. Variation propagation modeling and pattern mapping method for aircraft assembly structure considering residual stress from manufacturing process. *Proceedings of the Institution of Mechanical Engineers, Part B: Journal of Engineering Manufacture*. 2017; 231: 437-53.
2. Maropoulos PG, Muelaner JE, Summers MD and Martin OC. A new paradigm in large-scale assembly—research priorities in measurement assisted assembly. *Int J Adv Manuf Technol*. 2014; 70: 621-33.
3. Bi Y, Yan W and Ke Y. Optimal placement of measurement points on large aircraft fuselage panels in digital assembly. *Proceedings of the Institution of Mechanical Engineers, Part B: Journal of Engineering Manufacture*. 2017; 231: 73-84.
4. Estler WT, Edmundson KL, Peggs GN and Parker DH. Large-Scale Metrology – An Update. *CIRP Annals - Manufacturing Technology*. 2002; 51: 587-609.
5. Swyt DA. Uncertainties in Dimensional Measurements Made at Nonstandard Temperatures. *J Res Natl Inst Stand Technol*. 1994; 99: 31-44.
6. Schmitt RH, Peterek M, Morse E, et al. Advances in Large-Scale Metrology – Review and future trends. *CIRP Annals - Manufacturing Technology*. 2016; 65: 643-65.
7. BSI. BS EN ISO 1. Geometrical product specifications (GPS). Standard reference temperature for the specification of geometrical and dimensional properties. BSI, 2015.
8. Jayaprakash G, Thilak M and SivaKumar K. Optimal tolerance design for mechanical assembly considering thermal impact. *Int J Adv Manuf Technol*. 2014; 73: 859-73.
9. Jeang A, Hwan CL and Chen TK. A Statistical Dimension and Tolerance Design for Mechanical Assembly Under Thermal Impact. *The International Journal of Advanced Manufacturing Technology*. 2002; 20: 907-15.
10. Muelaner JE and Maropoulos PG. Large volume metrology technologies for the light controlled factory. 2014.
11. Mullineux G, Ross-Pinnock D and Yang B. Point-Based Models For Compensation Of Thermal Effects In Dimensional Metrology. In: Horvath I, Pernot J-P and Rusak Z, (eds.). Delft University of Technology, 2016.
12. Childs PRN, Greenwood JR and Long CA. Review of temperature measurement. *Review of Scientific Instruments*. 2000; 71: 2959-78.
13. Ross-Pinnock D and Maropoulos PG. Identification of Key Temperature Measurement Technologies for the Enhancement of Product and Equipment Integrity in the

Light Controlled Factory. *Procedia CIRP Special Edition for 8th International Conference on Digital Enterprise Technology - DET 2014 – Disruptive Innovation in Manufacturing Engineering towards the 4th Industrial Revolution*. Elsevier, 2014.

14. Ross-Pinnock D and Maropoulos PG. Review of industrial temperature measurement technologies and research priorities for the thermal characterisation of the factories of the future. *Proceedings of the Institution of Mechanical Engineers, Part B: Journal of Engineering Manufacture*. 2015.

15. Yang J, Mei X, Zhao L, Ma C, Shi H and Feng B. Thermal error compensation on a computer numerical control machine tool considering thermal tilt angles and cutting tool length. *Proceedings of the Institution of Mechanical Engineers, Part B: Journal of Engineering Manufacture*. 2015; 229: 78-97.

16. Yang J, Zhang D, Mei X, Zhao L, Ma C and Shi H. Thermal error simulation and compensation in a jig-boring machine equipped with a dual-drive servo feed system. *Proceedings of the Institution of Mechanical Engineers, Part B: Journal of Engineering Manufacture*. 2015; 229: 43-63.

17. Zhang Y, Yang J, Xiang S and Xiao H. Volumetric error modeling and compensation considering thermal effect on five-axis machine tools. *Proceedings of the Institution of Mechanical Engineers, Part C: Journal of Mechanical Engineering Science*. 2013; 227: 1102-15.

18. Liu H, Sun C, Zhang Y, et al. Hull deformation measurement for spacecraft TT&C ship by Photogrammetry. *Science China Technological Sciences*. 2015; 58: 1339-47.

19. Ross-Pinnock D. Integration of Thermal and Dimensional Measurement – A Hybrid Computational and Physical Measurement Method. *38th MATADOR Conference*. Huwei, Taiwan: The University of Manchester, 2015, p. 471-8.

20. Aicon. MoveInspect Technology DPA. <http://aicon3d.com/products/moveinspect-technology/dpa/at-a-glance.html>. (2016).

21. Systems F. FLIR® E-Series and E-Series bx — Now with MSX®. <http://www.flir.co.uk/instruments/display/?id=56911>. (2016).